

# ELMARK<sup>®</sup>

The Brand of Electricity



SMART HOME  
CATALOGUE | 2024

# SMART HOME

## Smart Hubs | Smart Sockets | Smart Switches [page 12](#)



iHost Smart Home Hub |  
page 12



Smart plug-in German  
type | page 16



Wireless USB smart  
adaptor | page 17



Smart socket German  
type IP55 | page 18



Wi-Fi smart wall switch  
EU/UK type | page 21



Wi-Fi smart wall touch  
fan switch EU/UK type |  
page 22



Wi-Fi smart wall touch  
dimmer switch EU/UK  
type | page 24



Electrical socket  
German type with glass  
frame | page 26



Double USB socket  
with glass frame |  
page 23



Smart WiFi panel EU  
type | page 31



Smart WiFi Pro panel EU  
type | page 33



Mini smart switch |  
page 34

## Smart DIY switches | [page 35](#)



S-mate switch |  
page 35



Two channel WiFi smart  
switch | page 38



Smart dimmer switch |  
page 39



Two way smart mini  
switch | page 40



Smart dimmer switch |  
page 41



Two way mini smart  
power meter switch |  
page 43



Smart WiFi POW ELITE  
power meter switch |  
page 44



Smart switch with  
power monitoring |  
page 45



Smart fan and light  
controller | page 48



Temperature and  
humidity monitoring  
WiFi switch | page 50



RF BRIDGE R2 433 smart  
hub | page 15



RF BRIDGE R2 433 smart  
hub | page 57

## Smart light control | [page 64](#)



Wi-Fi smart LED bulb |  
page 64

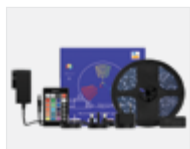

Smart LED strip |  
page 67



Digital LED strips |  
page 68



TUYA Smart digital  
music wall lights |  
page 70



Bluetooth LED strips |  
page 73



Bluetooth smart RGB  
LED strip | page 74



Bluetooth smart LED  
strip | page 74

# SMART HOME

## Smart and security cameras | [page 78](#)



Indoor wireless smart camera | page 78



Indoor wireless IP security camera | page 79

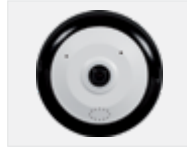

Indoor wireless smart camera | page 82



Outdoor TUYA smart Wi-Fi camera IP66 | page 84



Outdoor TUYA smart solar camera IP66 | page 85

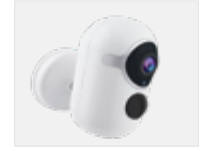

Outdoor smart WiFi camera with built-in battery | page 86



HD 2MP bullet camera IP66 | page 87



Video recorder with 4 cameras, set | page 87



8 channel digital video recorder | page 88



DVR and camera accessories | page 89

## Video door systems | Smart door locks | [page 91](#)

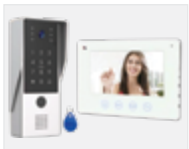

Wireless and video door phone | page 91

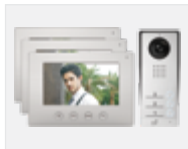

WiFi smart video intercom doorbell systems | page 92



Smart photo doorbell camera with wireless chime | page 94

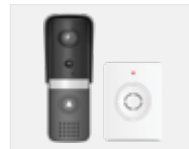

Smart wireless video doorbell TUYA | page 95



Solar video smart wireless door bell, TUYA | page 96



Electromagnetic strike plates | page 97



Fingerprint electronic smart door lock EL-T1 | page 101



Fingerprint electronic smart door lock EL-T6 | page 105



Fingerprint electronic smart lock for glass door L-G3 | page 107



Bluetooth TUYA fingerprint wireless door lock | page 108



Smart digital wireless TUYA door lock | page 109



Smart fingerprint wireless TUYA door cylinder | page 110

## Access control | Wireless doorbells | [page 114](#)



RFID standalone access controller with keypad | page 114



Controller for access control and time attendance | page 116



Access control and time attendance terminal | page 117



Face recognition, time attendance and access terminal | page 119



RFID Mini Weigand card reader 125 kHz | page 120



Manual parking lock | page 125



Wireless door bell | page 129



Wireless door bell | page 131



8-12V/230V Doorbells for DIN rail | page 134



## eWeLink & Tuya **SMART SOLUTIONS**

The installation of home automation devices in your home is the simplest and most innovative solution to save energy and reduce the cost of electricity and heating bills.

In an era where technology has become part of everyone's life, more and more people are choosing to equip their homes with a home automation system or at least smart devices for controlling lights and appliances.

Relying on home automation means living in a smart home, which improves the quality of life. The benefits of using technology in one's home go far beyond the thought of improving the quality of one's life, and the possibility of applying the technology by combining it with energy savings must also be considered.



### *Many devices - two APPs*

*All this, combined with the inexhaustible convenience provided by eWeLink and Tuya, give many options, make the use both reliable and convenient for every user.*

## Two APPs - many opportunities



## Two APPs - many control functions

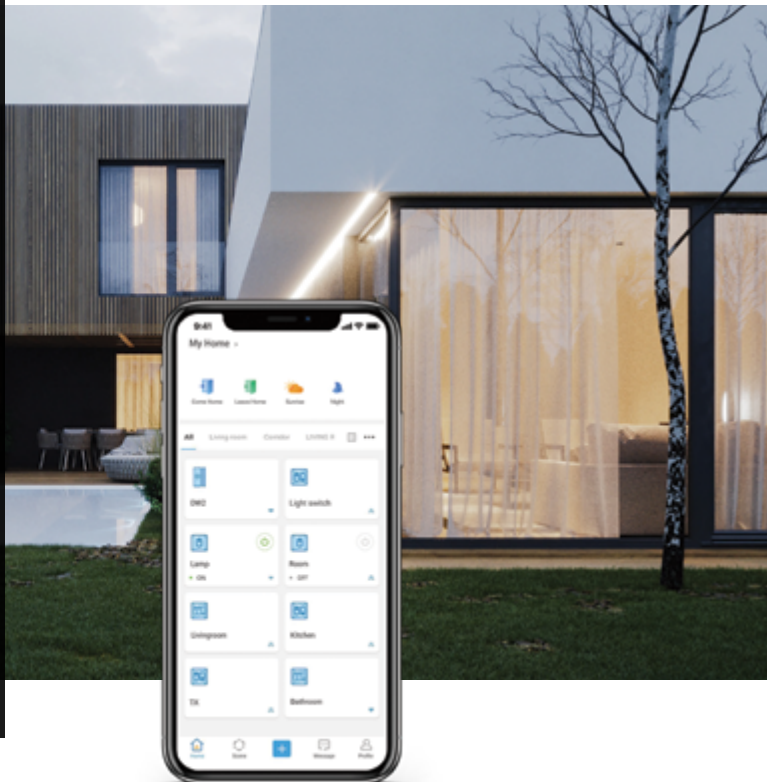
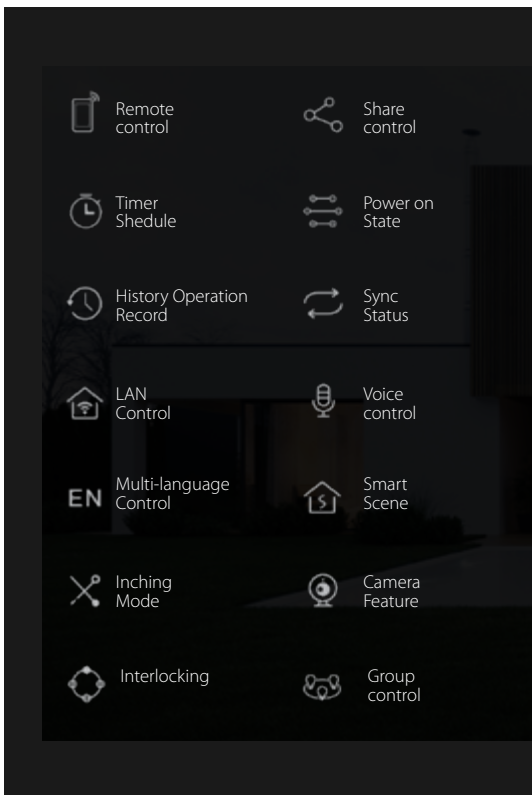

Select language on page 127:



The **ELMARK Smart solutions** includes products from the following product groups:

▶ **SMART PLUG-IN AND OUTDOOR SOCKETS**

Connect with the eWeLink app to turn existing appliances into smart devices, convenient to remotely control on your phone.

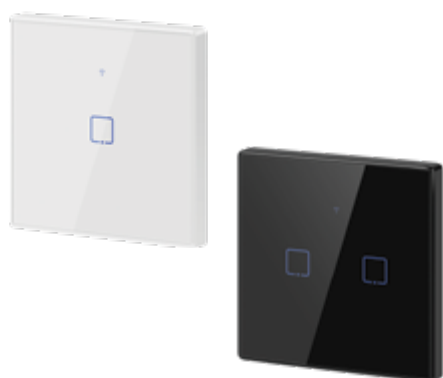
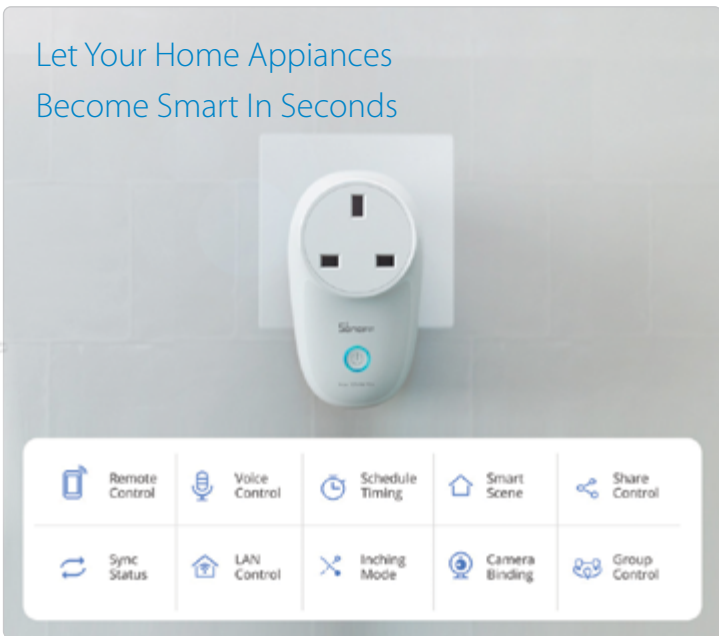

▶ **The NEW GLASS SWITCHES AND SOCKETS** work with WeLink app.

Include multiple smart touch switches from 1 to 3 gangs, dimers switches, switches for ventilation control, curtain switches in white and black colour.

**NO NEUTRAL WIRE REQUIRED**

Most from them don't need neutral wire by installation. Create a cast dashboard as you wish for your smart devices and control them directly from there.



◀▶ Curtain switch



Glass switches

▶ **CENTRAL CONTROL PANEL**

Control all your devices and scenes. Integrated gateway Zigbee with home security, compatible with more brands and functions.



**Control all in one panel**

Supports control on unlimited number of devices.



▶ **DIY SMART SWITCHES**

Combine various monitoring and control functions of the devices connected to them. Use your DIY remodeling ideas to automate your home.



▶ SMART SENSORS

See from a distance what the temperature and humidity are in the room, the temperature of the aquarium or the humidity in the pot with your favorite flower.



Waterproof Temperature Sensor



Temperature and Humidity Sensor

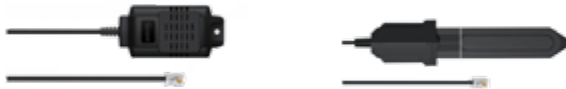
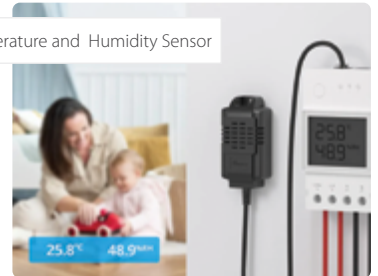

▶ SMART LIGHTING

Create your colorful life, bring the fancy atmosphere home

Enjoy the APP features  
Create your own Scenes



21 Recommended Scene Modes and Up to 8 DIY Scenes

Light up your outdoor or indoor events using the scene modes





▶ SMART MOTION, WINDOWS, SMOKE AND GAS DETECTORS

More security at every moment



Motion sensor

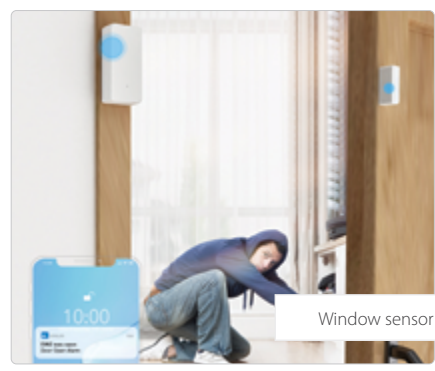

Window sensor

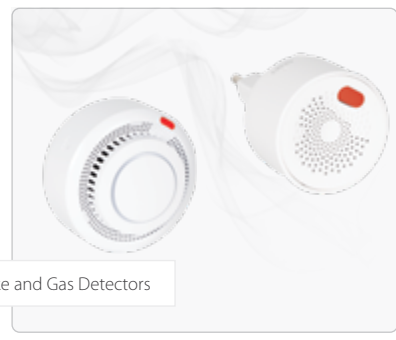

Smoke and Gas Detectors

▶ SMART AND SECURITY CAMERAS

Indoor and outdoor video surveillance suitable for every need. NEW cameras with autonomous power supply and batteries

3MP Solar Battery Camera  
365 Day protect your home.



### ▶ VIDEO DOOR SYSTEMS AND ELECTROMAGNETIC STRIKE PLATES

Innovative solution, which is becoming increasingly more frequent in the process of design of the contemporary residential buildings. The new method for control of the access to home is exceptionally comfortable and in accordance with the hectic lifestyle.



**Fingerprint Unlock -**  
more reliability and efficiency



Control from anywhere  
with TUYA app

### ▶ SMART DOOR LOCKS

5 ways to unlock- fingerprint, password, card.

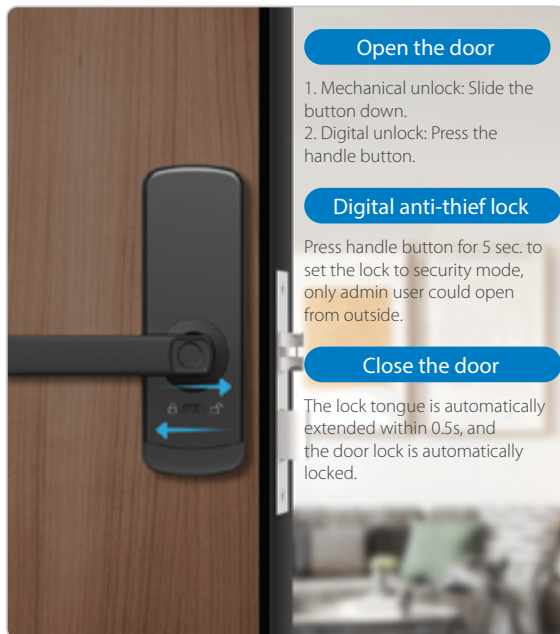

#### High sensitive fingerprint



#### Scramble pin code technology



## ▶ ACCESS CONTROL

RFID standalone, TCP/IP controllers, card readers and accessories for all access control needs.

### Standalone access control



- No need for a PC network.
- Precision electronic components.
- Stable performance.



### Access control and time attendance device

Professional access control functions:

- 50 time zones.
- 5 groups.
- 10 open door combination.
- Supports multi users entry.

### Moving hand sensor EXIT devices

intended for connection to access systems.



- Elegant design.
- Double LED indication.
- Long mechanical life.



Catalogue number:  
RV1109DDR42GB



## IHOST SMART HOME HUB WITH POSSIBILITY TO SECURITY CONTROL OF ALL SMART DEVICES IN THE WHOLE HOUSE

iHost Smart Home Hub is a private local server for your smart home system, It can not only realize the local connection and control of the devices and scene linkage, but also set smart security according to different scenes, and device data stays local & private.

Compatible with Wi-Fi LAN devices and Zigbee standard protocol devices.

It supports connecting and controlling LAN devices. Run the device even if the Internet is down and manage up to 128 sub-devices, work with Zigbee router devices can extend the Zigbee network range and realize the control of the whole house.

Local Data Storage and Manage stays local & private.

All data including scene logs, operation logs, security logs, etc is stored in a local database to protect your data security and each data type supports local storage of 2000 data.

Open API and Addon integration.

iHost supports open API and Docker containerization. You can install or develop more Add-on to make your smart life more convenient.



**CONTROL:** From Anywhere via Smart or LAN Devices

### FUNCTION

- Local Control Center: The iHost Smart Home Hub serves as your local control center, elevating your home automation experience to be faster, more reliable, and more secure.
- Local Automation: iHost supports settings local security modes and smart scenes.
- Local Data Storage & Manage: iHost is dedicated to delivering a swift and seamless home automation experience. With local data storage and management, rest assured your information remains local and private, safeguarding your data security

- Strong Compatibility: Fully compatible with Zigbee standard protocol devices and Wi-Fi LAN devices. Manage up to 128 sub-devices and, with a Zigbee router, extend the Zigbee network range for whole-home control. Through the eWeLink Smart Home Add-on, you can integrate Wi-Fi devices that support LAN control.
- Support wide range of device types: Zigbee, LAN, eWeLink. Allowing you to centralize smart devices at home within iHost
- iHost can serve as a Matter hub to add and manage other brands devices that support Matter, enabling control within the iHost platform

### TECHNICAL DATA

- Input voltage: 5V/ 2A
- Power supply interface type: Type-C
- Network interface type: RJ45
- Body material: ABS
- Wireless connection: WiFi IEEE 802.11 b / g / n 2.4GHz, Zigbee 3.0
- Storage: TF card max. 256GB (not included)



**3 YEARS TOTAL WARRANTY**  
+ 3 standard  
0 extended

iHost supports connecting and controlling various devices within the same local area network (LAN) of a router, allowing the creation of different usage scenarios of them.



**NIMBLE LED INDICATOR**

S5050 RGB LED indicator group independently controlled.

**FUNCTION BUTTON**

4 buttons with blue LED indicators for different basic functions.

**BUILT-IN MICROPHONE AND SPEAKER**

Various beeps for perfect human-computer interaction with the user.

**Take Compatibility Capabilities to the Next Level<sup>4</sup>**

After enabling Zigbee2CUBE, iHost will have stronger compatibility, allowing it to connect to a wider range of third-party devices such as Philips, IKEA, and others.



**Matter**

Matter Hub<sup>\*</sup>



**3 YEARS TOTAL WARRANTY**  
+ 3 standard  
0 extended



## RF BRIDGE R2 433 SMART HUB

This RF BridgeR2 433 can convert most of the 433.92MHz RF Remotes into WiFi wireless. By adding the RF wireless Bridge to iOS/Android App eWeLink WiFi wirelessly, You can add up to 16 RM 433 RF or alarms, also add them together (max. 16 items). One 4 button remote controller can learn 4 devices, which means 64 devices supporting 433 MHz frequency can be added on the app through WiFi/2/3/4G network.

It can be used for most of the 433.92MHz RF Remote controlled products, like RF controlled switch, RF controlled socket, RF controlled bulb, RF controlled door opener, etc. You can set totally 8 schedule/countdown/loop timers to turn on/off the RF controlled products.

Even more exciting is that it will work with the 433.92MHz door magnetic sensor, 433.92MHz human body IR sensor, and more other 433.92MHz sensors to realize security alarm, and allowing you to DIY smart scenes. Note that the alarm push only comes in the owner's account, those users being shared can't view the alarm push.

The RF BridgeR2 can work with SONOFF DW2-RF wireless door/window sensor that allows users to set the smart scene for the sensor and the device to be controlled, then when you open the door, the device will be triggered on.

**CONTROL:** From Anywhere via Smart Device. Remote and LAN Control

### FUNCTION

- **RF433MHz And Wi-Fi Protocol Supporting:** Help 433MHz RF devices to communicate with WiFi devices, extend the smart home ecosystem.
- **Strong Connectivity, Limitless Possibility:** The bridge supports adding RF 433MHz devices up to 64 that SONOFF has released, like PIR3-RF PIR Motion Sensor and DW2-RF Wireless Door/Window Sensor, making your home smarter.
- **Compatible With 433MHz Remote Controller & Easy Management:** Having dozens of RF433MHz devices and troubled in control them in a mess, this RF BridgeR2 will help you get rid of it. Just migrate them to your phone. With Compatible with 433MHz remote controller for easier control. You can add up to 16 devices and up to 64 buttons.
- **RF Alarm & Trigger Smart Scenes:** Can add alarms to trigger the device by setting a smart scene. For example, once the door is opened (Matched with DW2 door/window sensor), you will receive a notification with your lights on automatically.

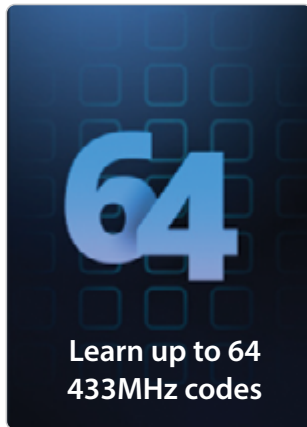

Remote Control



Voice control



Schedule Timing



RF Control



Alarm & Recording



Smart Scenes



LAN Control

Download eWeLink Application.

Full info for the products, instructions can be found at [www.elmarkholding.eu](http://www.elmarkholding.eu)



**3 YEARS TOTAL WARRANTY**  
+ 3 standard  
0 extended

**TECHNICAL DATA**

- Input voltage: 5V / 1A
- RF: 433.92 MHz
- Wireless Standard: 802.11 b/g/n 2.4 GHz
- Enclosure Material: PC V0
- Dimension (LxWxH): 62x62x20 mm

Catalogue number	Input voltage	RF	Wi-Fi	Packing/Box (pcs)
RFBRIDGER2	5V/ 1A	433.92 MHz	802.11 b/g/n 2.4 GHz	1

Scan and watch detailed video with all product functions.



**Multiple timer ways**

**Specified time**

Automatically turn lights at 11:00 pm every weekday.

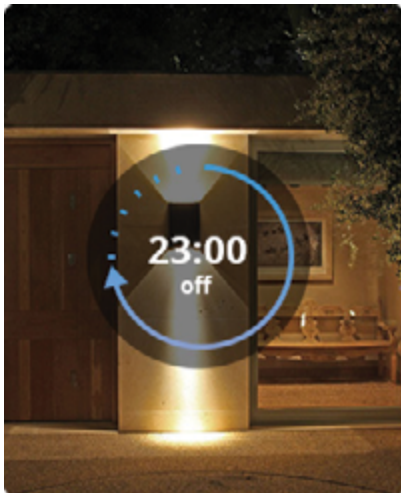

**Countdown**

Close the curtain after half an hour.

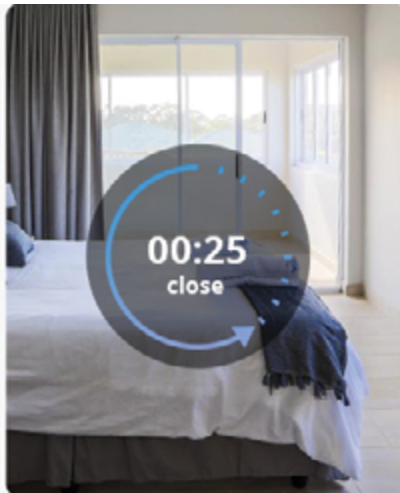

**Loop execution**

Turn on and off the heater every 10 minutes to maintain a constant temperature.



**433MHz RF ↔ Wi-Fi Hub**  
RF BridgeR2

Turn your traditional 433MHz RF remote control into smart.  
Add 433MHz RF sensors to create smart scenes and build your home security system.

**Works with More Ecosystems**

works with Hey Google | works with alexa | works with Smartthings | works with Alice

**NOTE 1:** The RF Bridge only supports the fixed code 433.92MHz frequency device, like PT2260, PT2262, PT2264, and EV1527, it is compatible with all Sonoff RF 433MHz products. The product doesn't support to learn rolling code and dynamic code. You can't see device status changes in the App.

**NOTE 2:** What's new on Android & iOS 2.5.0 and higher versions?

- Scheduled/countdown timers are supported.
- iOS App supports to add this product.
- 433MHz RF curtain switch and RF alarm are supported.

**3 YEARS TOTAL WARRANTY**  
+ 3 standard  
0 extended



German type



UK type

## WI-FI SMART PLUG-IN SOCKET GERMAN TYPE/ UK TYPE

These smart sockets provide the simplest way to automate your devices and appliances, it is a smart Wi-Fi heavy-duty plug-in outlet that installs in any receptacle, users can instantly convert any plug into a smart outlet with a convenient timer function that works on user's smartphone. You can turn on/off any connected device either on the APP eWeLink or by pressing the manual control knob of the WiFi plug. You can set countdown/single/repeat timers to auto-turn on/off the WiFi controlled outlet on App and can share the WiFi plug with your family so that you can control together, this makes it perfect to control lighting and other home appliances. What's more, S26R2 is also compatible with most voice-activated assistants that, such as Amazon Alexa and Google Assistant.

**CONTROL:** From anywhere via Smart device

### FUNCTION

- Remote Control From Anywhere: WiFi Plug can turn on or off your connected appliances from anywhere using eWeLink app
- Keep Your Life On Schedule: You can better control and organize your life with the scheduling benefits
- Create Smart Scenes: Set your own scenes where necessary, make your home smarter
- Group Controller: With a single touch of one button, you can manage multiple smart plugs simultaneously.
- Smart Voice Control: Works with Amazon Alexa and Google Assistant
- Heavy Duty: Equipped to handle higher loads, up to 16A. Plug-in appliances that require more amps such as, fans, heaters, slow cooker, etc.
- IFTTT function- Do even more with SONOFF Products, by connecting "eWeLink Smart Home" ON IFTTT App or ifttt.com, Use IFTTT to connect SONOFF products with hundreds of apps and web services. It's a whole new world of automation at your fingertips.

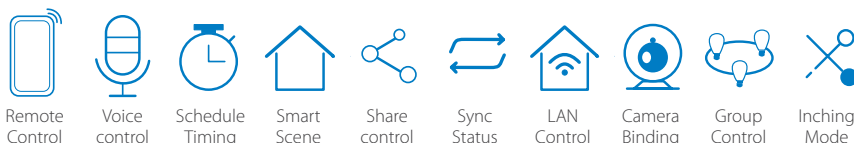

Download eWeLink Application. Full info for the products, instructions can be found at [www.elmarkholding.eu](http://www.elmarkholding.eu)

### TECHNICAL DATA

- Input voltage: 240VAC
- Output current German type/ UK type: 16A/ 13A
- Output Power German type/ UK type: 4000W/ 3250W
- Wi-Fi: IEEE 802.11 b/g/n 2.4GHz
- Material: PC V0

Catalogue number	Socket Type	Input voltage	Output current	Output power	Packing/Box (pcs)
S26R2TPF-DE	German	100-240VAC	16A	4000W	1/140
S26R2TPG-UK	UK	100-240VAC	13A	3250W	1/140

Scan and watch detailed video with all product functions.



#### Remote control from anywhere

Turn On or Off your connected appliances from anywhere using eWeLink app.

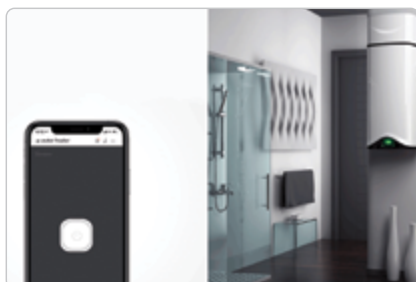

#### Keep your life on schedule

Control and organize your life with the scheduling benefits.

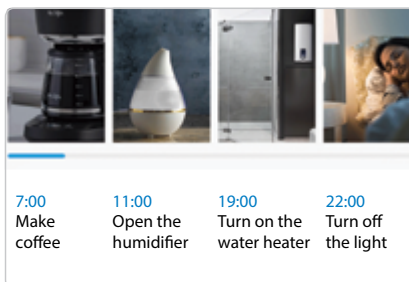

#### Create smart scenes, make your home smarter



**3 YEARS TOTAL WARRANTY**  
+ 3 standard  
0 extended





## WIRELESS USB SMART ADAPTOR, MICRO

USB smart adaptor with 5V input and output - Micro that makes your USB devices smart as well as provides convenience and security when you charge USB devices. Connect your USB devices with it and you will control the connected USB devices via eWeLink APP or Alexa and Google Home. The small size as your ordinary USB power adaptor, easy for you to take it anywhere around the world to charge.

**CONTROL:** From anywhere via Smart device

### FUNCTION

- Remote Control From Anywhere: with one tap via iOS & Android smartphones, with no distance limitation
- Voice Control: Smart WiFi USB adaptor is compatible with Amazon Alexa ( Amazon Echo/Echo Dot/Amazon Tap), Google Home Assistant, SmartThings and Alice. It allows you to use your voice to control home USB devices and enjoy a hands-free experience.
- LAN Control: LAN control allows your device to be controlled from your phone even if it is disconnected from the server.
- Smart Scenes: Trigger other smart devices, make actions auto-on/off or gather multiple devices into one group and tap to run them together. Multiple conditions, sunrise and sunset, timing, and other more smart scene waiting for you to explore.
- Timing Schedule: By presetting timers or schedules on the eWeLink App, your USB LED light strips can be automatically turned on/off at a specific time. Automate your home appliances via different timing schedules, such as USB lamps, USB fan, USB water pump, etc.

### Always consider your safety



- High heat-resistance
- Flame-retardant
- Ultra-durable



APP Control



Voice control



Schedule Timing



Smart Scenes



Sync Status



LAN Control



Power-on Status



Share control

Download eWeLink Application.

Full info for the products, instructions can be found at [www.elmarkholding.eu](http://www.elmarkholding.eu)

### TECHNICAL DATA

- Input: Max. 5 VDC/2.5A (USB Type A-male)
- Output: Max. 5 VDC/2.5A (USB Type A-male). Support only BC1.2 charging protocol. Max. 1A output for charging
- Wi-Fi: IEEE 802.11 b/g/n 2.4GHz
- Material: PC V0
- Dimensions LxWxH: 45x30x26 mm
- Product weight: 17g

Catalogue number	Input type	Output type	Output	Colour	Packing/Box (pcs)
MICRO	Male	Female	2.5A	White	1/400

Scan and watch detailed video with all product functions.



### Designed for "Easy to go"

Ideal for all your USB power adaptors and USB cable types

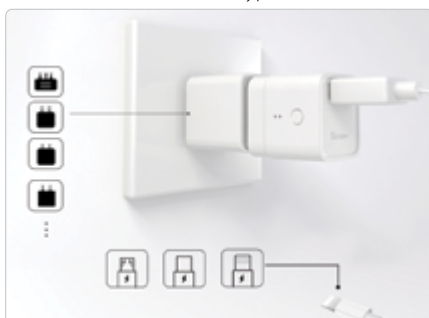

### Schedule, reduce your daily tasks

Automatically lights up on the opening time and lights off on the closing time



### Works with your devices





Specially design for outdoor use



## WI-FI SMART WATERPROOF SOCKET GERMAN TYPE, IP55

S55 is a handy Waterproof Smart Socket that can connect to your home Wi-Fi network and make you manage and program devices from far with your phone or voice via Amazon Alexa or Google Assistant. Adopts heavy-duty IP55 weather resistant material ensures it is rugged and safe when you use it outside. Customize schedules for devices to let them switch on/off automatically according to your needs wherever you are. Perfect for various occasions like garden, patio, open-air restaurant and more. Easy to install.

**CONTROL:** From anywhere via Smart device

### FUNCTION

- Remote Control From Anywhere: WiFi Plug can turn on or off your connected appliances from anywhere using eWeLink app
- Smart Scene: Full of limitless possibilities. Set one device to trigger another one or activate a group of devices via a single tap.
- Voice Control: Do not want to stand up to turn off the light? Just talk to Alexa/Google Assistant to control your devices.
- Power-On Status: Power-on state can keep the status before power cut, never forget to turn off the electrical appliances. Three states, ON, OFF, Last state, are waiting for you to choose.
- IP55 Waterproof: Can still use it outdoor.
- IFTTT function- Do even more with SONOFF Products, by connecting "eWeLink Smart Home" on IFTTT App or ifttt.com, Use IFTTT to connect SONOFF products with hundreds of apps and web services. It's a whole new world of automation at your fingertips.



APP Control



Voice control



Schedule Timing



IP55 Waterproof



Share control



Smart Scenes



Power-on Status

IFTTT

IFTTT Function

Download eWeLink Application.

Full info for the products, instructions can be found at [www.elmarkholding.eu](http://www.elmarkholding.eu)

### TECHNICAL DATA

- Input voltage: 240VAC
- Output current: 16A
- Output Power: 4000W
- Wi-Fi: IEEE 802.11 b/g/n 2.4GHz
- Material: PC V0

Catalogue number	Socket Type	Input voltage	Output current	Output power	Packing/Box (pcs)
S55TPF-DE	German	100-240VAC	16A	4000W	1/50

Scan and watch detailed video with all product functions.



Schedule the right On & Off time based on your needs

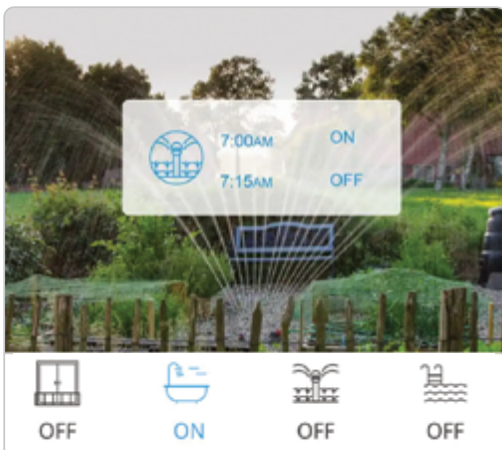

Make one device to trigger another one or activate group of devices via a single tap

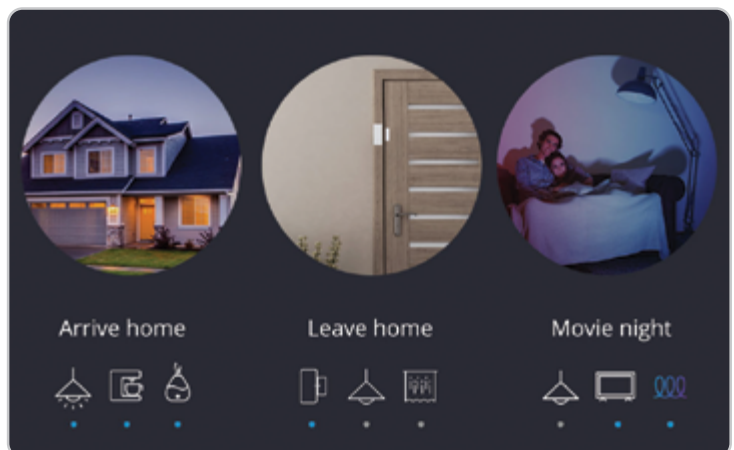

**3 YEARS TOTAL WARRANTY**  
+ 3 standard  
0 extended



Specially design for outdoor use



## WI-FI SMART PLUG-IN SOCKET UK TYPE, IP55

S55 is a handy Waterproof Smart Socket that can connect to your home Wi-Fi network and make you manage and program devices from far with your phone or voice via Amazon Alexa or Google Assistant. Adopts heavy-duty IP55 weather resistant material ensures it is rugged and safe when you use it outside. Customize schedules for devices to let them switch on/off automatically according to your needs wherever you are. Perfect for various occasions like garden, patio, open-air restaurant and more. Easy to install.

**CONTROL:** From anywhere via Smart device

### FUNCTION

- Remote Control From Anywhere: WiFi Plug can turn on or off your connected appliances from anywhere using eWeLink app
- Smart Scene: Full of limitless possibilities. Set one device to trigger another one or activate a group of devices via a single tap.
- Voice Control: Do not want to stand up to turn off the light? Just talk to Alexa/Google Assistant to control your devices.
- Power-On Status: Power-on state can keep the status before power cut, never forget to turn off the electrical appliances. Three states, ON, OFF, Last state, are waiting for you to choose.
- IP55 Waterproof: Can still use it outdoor.
- IFTTT function- Do even more with SONOFF Products, by connecting "eWeLink Smart Home" on IFTTT App or ifttt.com, Use IFTTT to connect SONOFF products with hundreds of apps and web services. It's a whole new world of automation at your fingertips.



APP Control



Voice control



Schedule Timing



IP55 Waterproof



Share control



Smart Scenes



Power-on Status

IFTTT

IFTTT Function

Download eWeLink Application.

Full info for the products, instructions can be found at [www.elmarkholding.eu](http://www.elmarkholding.eu)

### TECHNICAL DATA

- Input voltage: 240VAC
- Output current: 13A
- Output Power: 3250W
- Wi-Fi: IEEE 802.11 b/g/n 2.4GHz
- Material: PC V0

Catalogue number	Socket Type	Input voltage	Output current	Output power	Packing/Box (pcs)
S55TPG-UK	UK	100-240VAC	13A	3250W	1/50

Scan and watch detailed video with all product functions.



Schedule the right On & Off time based on your needs | Show the real-time status of your appliances on the APP  
Make one device to trigger another one or activate group of devices via a single tap



**3 YEARS TOTAL WARRANTY**  
+ 3 standard 0 extended

## WI-FI SMART WALL TOUCH SINGLE LIVE LINE SWITCHES EU/UK TYPE



**No neutral wire required**

A smart Wi-Fi switch with a classic design. It is durable and reliable, while providing a smooth operation and the flexibility to control power from anywhere through your smart phone. It can automatically recognize the connected devices and supports voice control via Amazon Alexa and Google Assistant.

**CONTROL:** From anywhere via Smart device or local via touching.

### FUNCTION

- Remote Control & Sync Status: Just tap on eWeLink App to turn on/off your device anytime and anywhere, and get the sync status of your devices.
- Touch Control: A slight tap for easier control, a modern and elegant decoration on your wall surface.
- Timer & Schedule: Set up timing schedules to turn on/ off lights.
- Hands-Free Voice Control: Compatible with Alexa & Google Assistant, use your voice to control the devices
- Switch with light: for easy detection in the dark
- Suitable for mounting in round and in square console box.



APP Control



Voice control



RF Control



Touch Control



Share control



Smart Scenes



Schedule Timing



LED Back light

Download eWeLink Application.

Full info for the products, instructions can be found at [www.elmarkholding.eu](http://www.elmarkholding.eu)

**3 YEARS TOTAL WARRANTY**  
+ 3 standard  
0 extended

### Hands-free voice control

Compatible with Alexa and Google Home



### Support timer function

Includes countdown, single and repeat timer

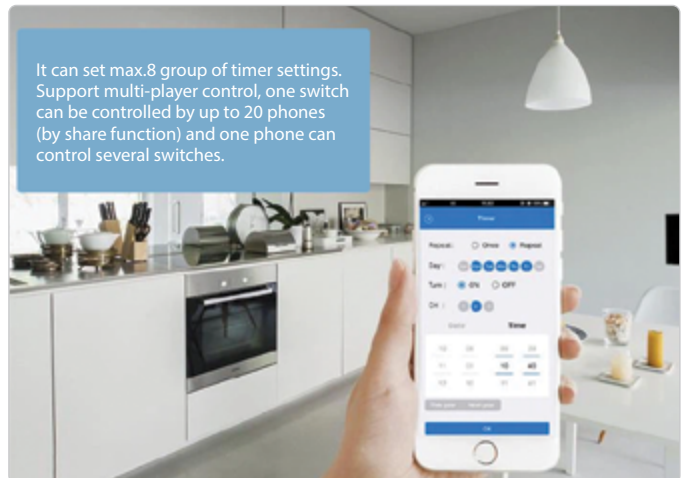



One gang/ White



Two gangs/ Black



Three gangs/ White

**TECHNICAL DATA**

- Gang: 1; 2; 3
- Ways: 1
- Application: eWelink
- Wireless Standard: IEEE 802.11 b/g/n
- Powered by a single live line
- Materials: Crystal glass panel, high quality flame retardant PC base
- Colour: White; Black
- Size: 86x86x24mm

Catalogue number	Output power	Gang	Way	Colour	Packing/Box (pcs)
195007/WH	1000W	1	1	White	1/100
195007/BL	1000W	1	1	Black	1/100
195008/WH	2000W	2	1	White	1/100
195008/BL	2000W	2	1	Black	1/100
195009/WH	2000W	3	1	White	1/100
195009/BL	2000W	3	1	Black	1/100



Scan and watch detailed video with all product functions.

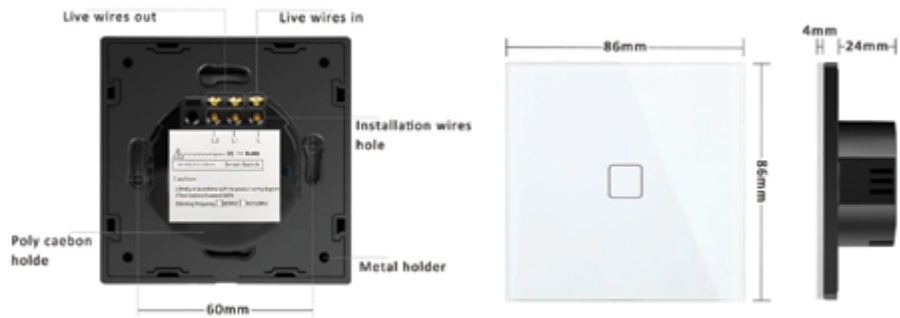

**3 YEARS TOTAL WARRANTY**  
+ 3 standard 0 extended

**No neutral wire required**

**Damp proof**

Works even in humid conditions



**Light indicator for the state**

Light-on state | Light-off state





Neutral wire required

## WI-FI SMART WALL TOUCH FAN SWITCHES EU/UK TYPE

A smart Wi-Fi switch with a classic design. It is durable and reliable, while providing a smooth operation and the flexibility to control power from anywhere through your smart phone. It can automatically recognize the connected devices and supports voice control via Amazon Alexa and Google Assistant.

**CONTROL:** From anywhere via Smart device or local via touching.

### FUNCTION

- Remote Control & Sync Status: Just tap on eWeLink App to turn on/off your device anytime and anywhere, and get the sync status of your devices.
- Touch Control: A slight tap for easier control, a modern and elegant decoration on your wall surface.
- Timer & Schedule: Set up timing schedules to turn on/ off lights.
- Hands-Free Voice Control: Compatible with Alexa & Google Assistant, use your voice to control the devices
- Switch with light: for easy detection in the dark
- Suitable for mounting in round and in square console box.



APP Control



Voice control



RF Control



Touch Control



Share control



Smart Scenes



Schedule Timing



LED Back light

Download eWeLink Application.

Full info for the products, instructions can be found at [www.elmarkholding.eu](http://www.elmarkholding.eu)

### TECHNICAL DATA

- Input voltage: 110-220V AC
- Application: eWeLink
- Wireless Standard: IEEE 802.11 b/g/n
- Powered by null & live line
- Materials: Crystal glass panel, high quality flame retardant PC base
- Size: 86x86x24mm

Catalogue number	Output power	Colour	Packing/ Box (pcs)
195010/WH	300W	White	1/100
195010/BL	300W	Black	1/100

**3 YEARS TOTAL WARRANTY**  
+ 3 standard  
0 extended

Scan and watch detailed video with all product functions.



### Hands-free voice control

Compatible with Alexa and Google Home

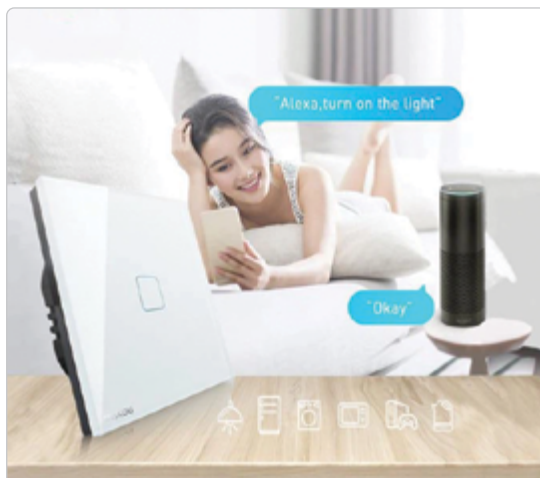

### Support timer function

Includes countdown, single and repeat timer

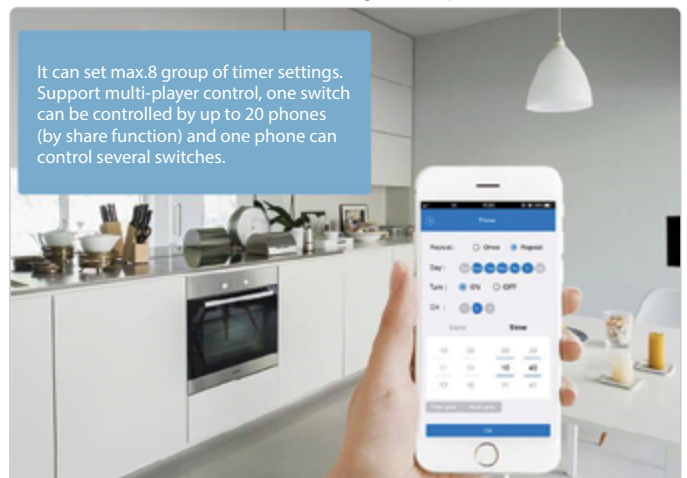

## WI-FI SMART WALL TOUCH CURTAIN SWITCHES EU/UK TYPE

A smart Wi-Fi switch with a classic design. It is durable and reliable, while providing a smooth operation and the flexibility to control power from anywhere through your smart phone. It can automatically recognize the connected devices and supports voice control via Amazon Alexa and Google Assistant.

**CONTROL:** From anywhere via Smart device or local via touching.

### FUNCTION

- Remote Control & Sync Status: Just tap on eWeLink App to turn on/off your device anytime and anywhere, and get the sync status of your devices.
- Touch Control: A slight tap for easier control, a modern and elegant decoration on your wall surface.
- Timer & Schedule: Set up timing schedules to turn on/ off lights.
- Hands-Free Voice Control: Compatible with Alexa & Google Assistant, use your voice to control the devices
- Switch with light: for easy detection in the dark
- Suitable for mounting in round and in square console box.



**Neutral wire required**



APP Control



Voice control



RF Control



Touch Control



Share control



Smart Scenes



Schedule Timing



LED Back light

### Damp proof

Works even in humid conditions



Download eWeLink Application.

Full info for the products, instructions can be found at [www.elmarkholding.eu](http://www.elmarkholding.eu)

### TECHNICAL DATA

- Input voltage: 110-220V AC
- Application: eWeLink
- Wireless Standard: IEEE 802.11 b/g/n
- Powered by null & live line
- Materials: Crystal glass panel, high quality flame retardant PC base
- Size: 86x86x24mm

Catalogue number	Output power	Colour	Packing/Box (pcs)
195011/WH	1000W	White	1/100
195011/BL	1000W	Black	1/100



Scan and watch detailed video with all product functions.

### Hands-free voice control

Compatible with Alexa and Google Home

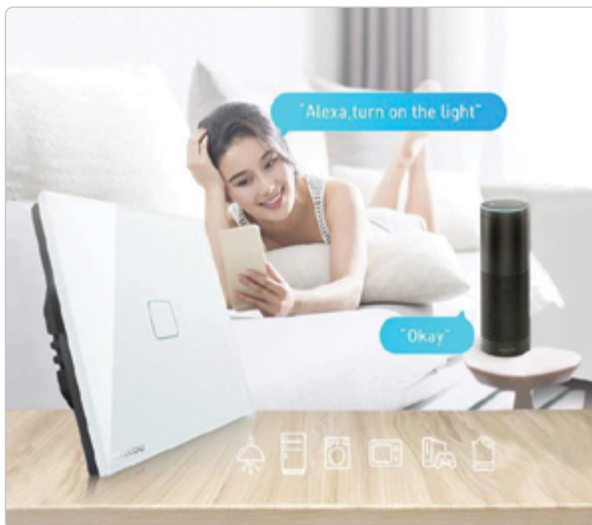

### Wi-Fi curtain switch

More simple and fashionable





**Neutral wire required**

**Damp proof**

Works even in humid conditions



**WI-FI SMART WALL TOUCH DIMMER SWITCHES EU/UK TYPE**

A smart Wi-Fi switch with a classic design. It is durable and reliable, while providing a smooth operation and the flexibility to control power from anywhere through your smart phone. It can automatically recognize the connected devices and supports voice control via Amazon Alexa and Google Assistant.

**CONTROL:** From anywhere via Smart device or local via touching.

**FUNCTION**

- Remote Control & Sync Status: Just tap on eWeLink App to turn on/off your device anytime and anywhere, and get the sync status of your devices.
- Touch Control: A slight tap for easier control, a modern and elegant decoration on your wall surface.
- Timer & Schedule: Set up timing schedules to turn on/ off lights.
- Hands-Free Voice Control: Compatible with Alexa & Google Assistant, use your voice to control the devices
- Switch with light: for easy detection in the dark
- Suitable for mounting in round and in square console box.



APP Control



Voice control



RF Control



Touch Control



Share control



Smart Scenes



Schedule Timing



LED Back light

Download eWeLink Application.

Full info for the products, instructions can be found at [www.elmarkholding.eu](http://www.elmarkholding.eu)

**TECHNICAL DATA**

- Input voltage: 110-220V AC
- Application: eWeLink
- Wireless Standard: IEEE 802.11 b/g/n
- Powered by null & live line
- Materials: Crystal glass panel, high quality flame retardant PC base
- Size: 86x86x24mm

Catalogue number	Output power	Colour	Packing/ Box (pcs)
195012/WH	500W	White	1/100
195012/BL	500W	Black	1/100



Scan and watch detailed video with all product functions.

**Hands-free voice control**  
Compatible with Alexa and Google Home



**Support timer function**  
Includes countdown, single and repeat timer

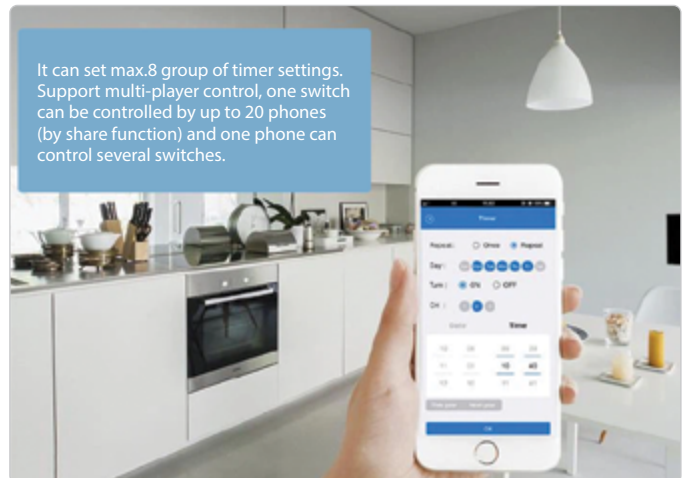

**3 YEARS TOTAL WARRANTY**  
+ 3 standard  
0 extended





## RF433 WALL TOUCH DIMMER SINGLE LIVE LINE SWITCHES EU/UK TYPE

Remote Dimmer Switch can be controlled by remote controller. This makes it easier to use and allows you to remotely control the lighting from all corners of the room.

**CONTROL:** Local with remote control or via touching

### TECHNICAL DATA

- Gang: 1; 2; 3
- Ways: 1
- Receiving frequency: 433MHz
- Powered by single live line
- Materials: Crystal glass panel, high quality flame retardant PC base
- Size: 86x86x24mm
- Colour: White; Black
- Remote control: Not included

Catalogue number	Output power	Gang	Way	Colour	Packing/ Box (pcs)
195013/WH	500W	1	1	White	1/100
195013/BL	500W	1	1	Black	1/100
195014/WH	500W	2	1	White	1/100
195014/BL	500W	2	1	Black	1/100
195015/WH	500W	3	1	White	1/100
195015/BL	500W	3	1	Black	1/100

**No neutral wire required**

### REMOTE CONTROL FOR RF433 WALL TOUCH DIMMER SWITCHES

Cat. Number  
195016



Scan and watch detailed video with all product functions.

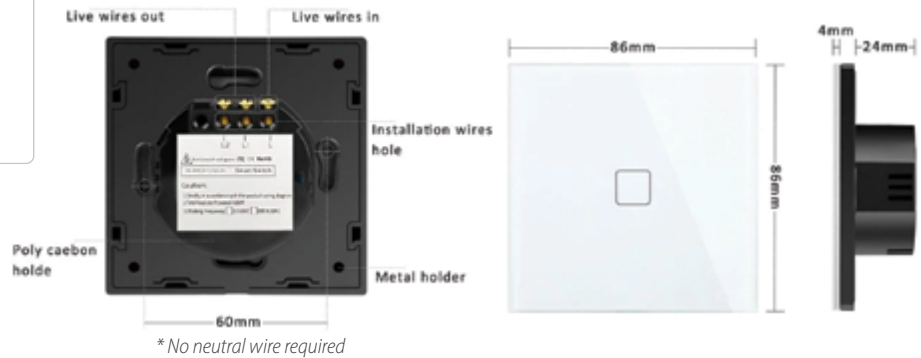

**Light indicator for the state**  
Light-on state | Light-off state



**Damp proof**  
Works even in humid conditions



**3 YEARS TOTAL WARRANTY**  
+ 3 standard 0 extended

## SWITCHES AND SOCKETS WITH GLASS PANELS



Available colours:  

### TECHNICAL DATA

- Input voltage: 220-240V AC
- Rated current: 16A
- Powered by null and single live line
- Materials: Crystal glass panel, high quality flame retardant PC base
- Size: 86x86x24mm
- Colour: White; Black
- The product comes complete with a console box for installation in concrete.



Console box  
Cat. number: 1927304

Catalogue number	Output power	Output current	Colour	Packing/Box (pcs)
195017CC/WH	3520W	16A	White	1/100
195017CC/BL	3520W	16A	Black	1/100



Available colours:  

## ELECTRICAL SOCKETS WITH USB, GERMAN TYPE WITH GLASS FRAMES

### TECHNICAL DATA

- Input voltage: 220-240V AC
- Rated current: 16A
- 2xUSB
- Powered by null and single live line
- Materials: Crystal glass panel, high quality flame retardant PC base
- Size: 86x86x24mm
- Colour: White; Black
- The product comes complete with a console box for installation in concrete.



Console box  
Cat. number: 1927303

Catalogue number	Output power	Output current	Colour	Packing/Box (pcs)
195018CC/WH	3520W	16A	White	1/100
195018CC/BL	3520W	16A	Black	1/100



**3 YEARS TOTAL WARRANTY**  
+ 3 standard  
0 extended



Available colours:  

## ELECTRICAL SOCKETS FRENCH TYPE WITH GLASS FRAMES

### TECHNICAL DATA

- Input voltage: 220-240V AC
- Rated current: 16A
- Powered by null and single live line
- Materials: Crystal glass panel, high quality flame retardant PC base
- Size: 86x86x24mm
- Colour: White; Black
- The product comes complete with a console box for installation in concrete.



Console box  
Cat. number: 1927304

Catalogue number	Output power	Output current	Colour	Packing/Box (pcs)
195019CC/WH	3520W	16A	White	1/100
195019CC/BL	3520W	16A	Black	1/100



Available colours:  

## ELECTRICAL SOCKETS UK TYPE WITH GLASS FRAMES

### TECHNICAL DATA

- Input voltage: 220-240V AC
- Rated current: 13A
- Powered by null and single live line
- Materials: Crystal glass panel, high quality flame retardant PC base
- Size: 86x86x24mm
- Colour: White; Black

Catalogue number	Output power	Output current	Colour	Packing/Box (pcs)
195024/WH	2860W	13A	White	1/100
195024/BL	2860W	13A	Black	1/100



**3 YEARS TOTAL WARRANTY**  
+ 3 standard  
0 extended



Available colours:  

## ELECTRICAL UNIVERSAL SOCKETS WITH USB AND GLASS FRAMES

### TECHNICAL DATA

- Input voltage: 220-240V AC
- Rated current: 13A
- 2xUSB
- Powered by null and single live line
- Materials: Crystal glass panel, high quality flame retardant PC base
- Size: 86x86x24mm
- Colour: White; Black

Catalogue number	Output power	Output current	Colour	Packing/Box (pcs)
195025/WH	2860W	13A	White	1/100
195025/BL	2860W	13A	Black	1/100



Available colours:  

## DOUBLE ELECTRICAL SOCKETS GERMAN TYPE WITH GLASS FRAMES

### TECHNICAL DATA

- Input voltage: 220-240V AC
- Rated current: 2x16A
- Powered by null and single live line
- Materials: Crystal glass panel, high quality flame retardant PC base
- Size: 147x86x24mm
- Colour: White; Black
- The product comes complete with a console boxes for installation in concrete.



Console boxes  
Cat. number: 1927304

Catalogue number	Output power	Output current	Colour	Packing/Box (pcs)
195026CC/WH	2x3520W	2x16A	White	1/100
195026CC/BL	2x3520W	2x16A	Black	1/100



**3 YEARS TOTAL WARRANTY**  
+ 3 standard  
0 extended



Available colours:  

## DOUBLE USB SOCKETS WITH GLASS FRAMES

### TECHNICAL DATA

- Input voltage: 220-240V AC
- Powered by null and single live line
- Materials: Crystal glass panel, high quality flame retardant PC base
- Size: 86x86x24mm
- Colour: White; Black

Catalogue number	Colour	Packing/Box (pcs)
195028/WH	White	1/100
195028/BL	Black	1/100



Available colours:  

## SINGLE LAN SOCKETS WITH GLASS FRAMES

### TECHNICAL DATA

- Category: Cat.5
- Materials: Crystal glass panel, high quality flame retardant PC base
- Size: 86x86x24mm
- Colour: White; Black

Catalogue number	Colour	Packing/Box (pcs)
195027/WH	White	1/100
195027/BL	Black	1/100



**3 YEARS TOTAL WARRANTY**  
+ 3 standard  
0 extended



## SMART WIFI PANEL EU STANDARD

Do you need one device to centrally control multiple electrical appliances in your home, from lights, heaters, coolers, curtains, doors, and windows? NSPanel can control all of these devices, offering an integrated HMI panel for home automation that is super convenient, all you need to do is -- one tap.

NSPanel Smart Scene Wall Switch is equipped with a built-in powerful thermostat and environmental sensors. You can set different indoor temperatures for different periods of time, and NSPanel will automatically trigger the heating or cooling equipment according to your setting conditions to keep the room at a comfortable temperature. What's more, NSPanel has a Scenario-based control function, you can set different modes for wake up, work, entertainment, and sleep, and can switch modes at any time.

Such a powerful panel, how to control it? There are three ways can control NSPanel Smart Scene Wall Switch: use the dual-channel switches or touchscreen at a close distance, use the APP to control when you are at a long distance.

NSPanel is compatible with various devices of SONOFF, such as smart led bulbs, LED Filament Bulb, LED light strips, S26/S31 plugs, TX, MINIR2, POWR3!

**CONTROL:** From anywhere via Smart device

### FUNCTION

- **All in One Control Center:** NSPanel can help you achieve the use of specific scene modes in different scenes with one tap. In addition to the scenario-based control, it is compatible with almost all sonoff devices and the central control function of the control group.
- **Integrated HMI Panel:** NSPanel centrally integrates HMI control, smart temperature control, and smart wall switch, turning your home into a convenient and smart place.
- **Home Automation Thermostat:** With a built-in powerful thermostat, you can set different indoor temperatures for different periods of time, and NSPanel will automatically trigger the heating or cooling equipment according to your setting conditions to keep the room at a comfortable temperature.
- **Multiple Ways to Control:** You can use the dual-channel switches, touchscreen, and eWeLink App to control SONOFF NSPanel; Besides, SONOFF NSPanel supports Alexa, Alice, Google Assistant, and even Siri Shortcuts, you can control your home appliances with simple voice control.
- **Know the Time & Weather:** With built-in sensors and WiFi connection, NSPanel smart scene wall switch can real-time updates weather, indoor temperature, outdoor temperature, time, and date.

<p><b>Integrated HMI Panel</b> One Tap to Various Home Automation on Just One Screen</p>		<p><b>Scenario-based Control</b> Convenient Control with Scenario-based Combination</p>
<p><b>Smart Lighting</b> One Seamless Way to Control Different Lights</p>	<p><b>Smart Temp-control</b> Automatic Temperature Monitoring and Adjusting with Built-in Sensors</p>	<p><b>Multiple Ways to Control</b> HMI Touch-screen Control, Remote App-control, Voice Control and Dual-button Switch Control</p>
<p><b>Know the Time and Weather</b> Outdoor Temperature, Indoor Temperature, Time and Date</p>		

Download eWeLink Application.

Full info for the products, instructions can be found at [www.elmarkholding.eu](http://www.elmarkholding.eu)

**3 YEARS TOTAL WARRANTY**  
+ 3 standard  
0 extended

**TECHNICAL DATA**

- Input voltage: 100-240VAC 50/60Hz
- Output power: 2x2A (4AMax.)
- Gang: 2
- LED load: 2x300W (Max.600W)
- TFT Screen: 3.5 Capacitive Touch Panel
- Wireless Standard: 802.11 b/g/n
- Bluetooth Standard: 4.2 BLE
- Enclosure Material: PC V0 + CRS + Glass
- Dimension (LxWxH): 86x86x41.7 mm

Catalogue number	Input voltage	Resistive current	Resistive load	Colour	Packing/Box (pcs)
NSPANEL-EU	100-240V AC	2x2A	2x300W	Black	1/100



Scan and watch detailed video with all product functions.

**Customize and preset the temperature you prefer**

NSPanel triggers the heating or cooling appliances automatically to keep the indoor temperature of your home at a certain point according to your schedule and settings.



**Instant access to scene-customization**

NSPanel allows you to preset specific conditions for different selected scenes so that you can trigger them at any time



**Multiple interactive ways of control**



**Close distance**

A convenient combination of HMI smart touch panel and dual-channel wall switch. Suitable for close-distance control over brightness, room temperature and more.

**Middle distance**

Super intelligent and sensitive voice control for home automation via Alexa, Google Assistant or Alice.

**Long distance**

Smart control your home via eWeLink App with its multinational features even at outdoors

**3 YEARS TOTAL WARRANTY**  
+ 3 standard 0 extended



## SMART WIFI PRO PANEL EU STANDARD

NSPanel Pro is a smart home control panel. Your smart lights, switches, heaters, coolers, curtains, and all your smart devices can be controlled. An unlimited number of control devices, all in one panel.

NSPanel Pro can quickly add Zigbee devices on the screen in batches. Standard Zigbee 3.0 protocol makes the connection more stable and the coverage wider. Support all SONOFF Zigbee devices such as Zigbee Sensors, ZBMINI, and BASICZBR3.

NSPanel Pro can be used as a display, supports adding four types of cameras for live monitoring. Viewing the real-time monitoring of living room, garage, bedroom, etc on the panel at any time. Power Consumption Graph, Customize Wallpaper, and Call Intercom.



**CONTROL:** Local or from Anywhere via Smart Device

### FUNCTION

- Multi-protocol Gateway: Support Wi-Fi, Zigbee, eWeLink app, Matter and Bluetooth
- All in one panel: Unlimited numbers of control devices like smart lights, smart cameras, sensors and switches. Support smart scenes, thermostats, power consumption statistics, group control and etc.
- Local control: Zigbee devices support local control and smart scenes. No longer relying on WI-FI to control.
- Customize your home security mode: 3 modes by setting different arming devices. Easy arm and disarm.
- Go out with easy: One click to enable Away Mode- turn off all appliances and turn ON alarm.
- Sleep mode: automatically turn OFF lights and close curtains, leaving a small night light to accompany you until morning.
- Use as doorbell: Panel and wireless button can act as the doorbell.
- Remote talk by camera: Used with a smart camera, when someone comes to visit, you can check the situation and speak with visitor via two way intercom.
- Smart temperature control: Choose the temperature source and execution devices to form your own thermostat.
- Check power consumption at any time: Smart panel help you live an eco friendly life.
- Call intercom: Support phone to panel and between panels calls
- Music rhythm console: The lights in the room change colours with the music rhythm and various modes are available.
- Weekly weather know in advance
- Upload your own wallpaper
- Use as alarm clock

Check power consumption at any time



Weekly weather know in advance



### Not only Smart Panel, but Zigbee Hub

Quickly add Zigbee devices on the screen in batches



**3 YEARS TOTAL WARRANTY**  
+ 3 standard  
0 extended



**TECHNICAL DATA**

- TECHNICAL DATA:
- Input voltage: 100-240VAC 50/60Hz
- Max. power consumption: 5W (150mA)
- Wireless Standard: 802.11 b/g/n
- Zigbee: IEEE 802.15.4 (Zigbee 3.0)
- TFT Screen: 3.95 Capacitive Touch Panel
- Screen resolution: 480x480
- MCU: PX30
- CPU: 4-cores Cortex-A35
- GPU: Mali-G31GPU
- RAM: 2GB, DDR3
- ROM: 8GB, eMMC 5.1
- Enclosure Material: PC V0 + CRS + Glass
- Colour: Dark grey
- Dimension (LxWxH): 86x86x39.5 mm

Catalogue number	Input voltage	Screen resolution	Colour	Packing/ Box (pcs)
NSPANEL86PB	100-240VAC	480x480	Dark grey	1/100



Scan and watch detailed video with all product functions.

**Remote talk by camera**

Used with a smart camera, when someone comes to visit, check the situation through the camera first to confirm safety. It also supports two-way talk to make communication easier.

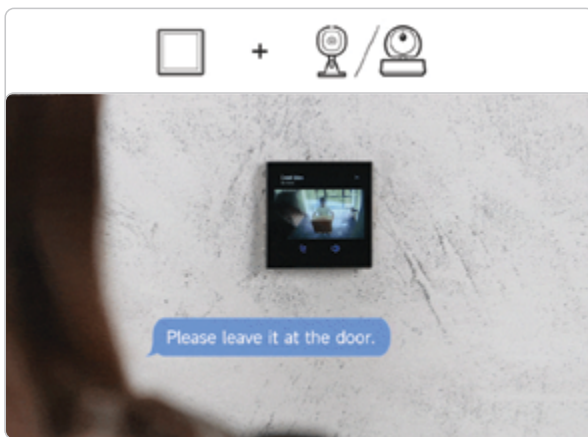

**Security Alert**

After arming, once the sensor is triggered, the panel will alarm and you will receive a notification alert on your phone.

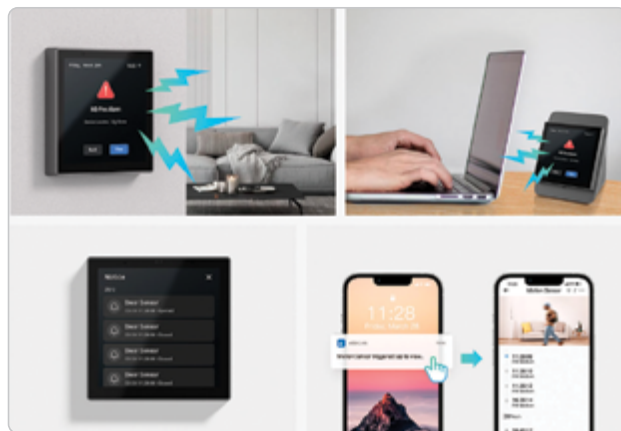

**3 YEARS TOTAL WARRANTY**  
+ 3 standard  
0 extended

**Smart temperature control**

Choose the temperature source and execution devices to form your own thermostat.

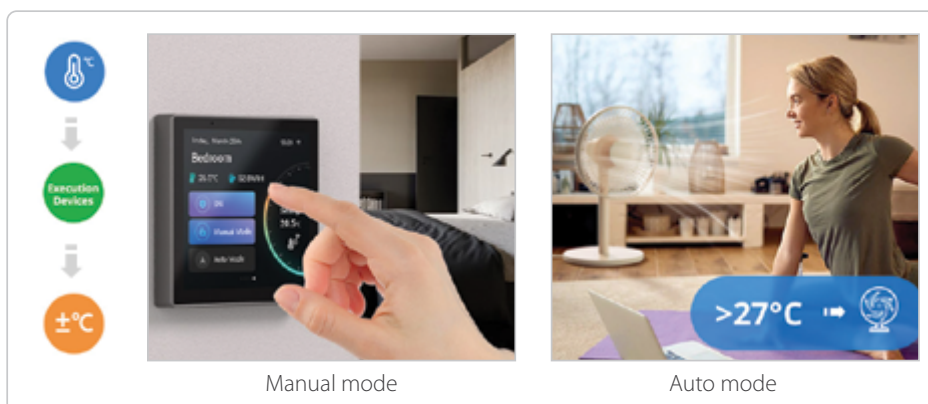



### MINI WIFI SMART SWITCH, MINI R3

MINI R3 is a small body with powerful functions, the maximum load current can be up to 16A that making it a powerful solution to smarten your appliances. MINI R3 is compatible with Alexa, Google Assistant, Siri shortcut, and Alice. Just say your needs out, the smart device can do what you want to do. With the sync status on eWeLink App, your worry about leaving the appliances on at home is no longer a concern. Just pull out your phone and tap on it.

MINI R3 have been tested for safety and comply with the requirement of international regulations, as TÜV certified and FCC&CE certification ensures high trust, quality, and safety.

**CONTROL:** From anywhere via Smart device

**FUNCTION**

- Max. 16A Load Current: The maximum load current of MINI R3 can be up to 16A that making it a powerful solution to smarten your appliances.
- Open Device REST API: Connect and control the MINI R3 with your existing home automation system like Home Assistant via LAN.
- "eWeLink-Remote" Control: MINI R3 is a smart switch with the gateway function of "eWeLink-Remote". If you want to use the "eWeLink-Remote" control function, you need to use it with the S-MATE or scene switch R5.
- No Neutral Wire Required Solution: If your switch box does not have a neutral wire, a collocation of MINI R3 and S-MATE can be installed and used.
- Safe And Reliable: TÜV, CE, and FCC certifications ensure a safer and more reliable product.

**"NEW" Smart switch solution for switch box with NO neutral wire**

	<b>16A</b>
	<b>"NO NEUTRAL WIRE" solution</b>
	<b>Remain existing switches</b>

						<b>DIY</b>	<b>MINI</b>
Control Anywhere	Voice control	Schedule Timing	LAN Control	Inching Mode	Group Control	DIY Mode	Small & Compact

Download eWeLink Application.  
Full info for the products, instructions can be found at [www.elmarkholding.eu](http://www.elmarkholding.eu)

**TECHNICAL DATA**

- Input voltage: 100-240V AC, 50/60Hz
- Output current: Max 16A
- Max. Power: 3500W(16A)
- Wireless Standard: 802.11 b/g/n
- Security Mechanism: WPA-PSK/WPA2-PSK
- Enclosure Material: PC V0
- Dimension (LxWxH): 54x54x24 mm

**3 YEARS TOTAL WARRANTY**  
+ 3 standard 0 extended

Scan and watch detailed video with all product functions.



Catalogue number	Input voltage	Resistive current	Resistive load	Colour	Packing/Box (pcs)
MINIR3	100-250V AC	16A	3500W	White	1/800

Control your devices no matter where you are via eWeLink APP



Siri voice control is a shortcut of Siri in eWeLink APP

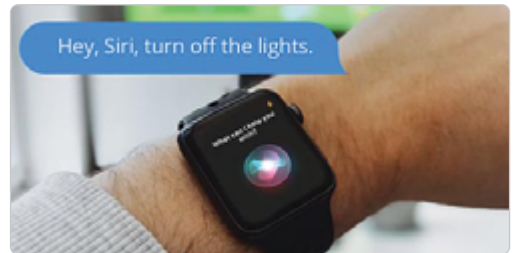

Use your voice!  
No need to stand up to switch off the lights.

Set a smart scene and make your life even smarter

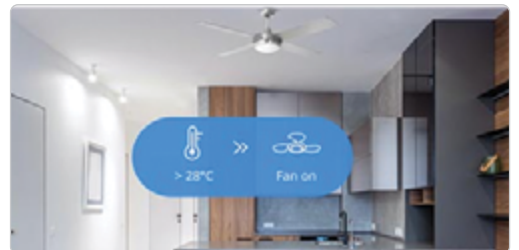



One S-MATE with more MINI R3 creates more possibilities

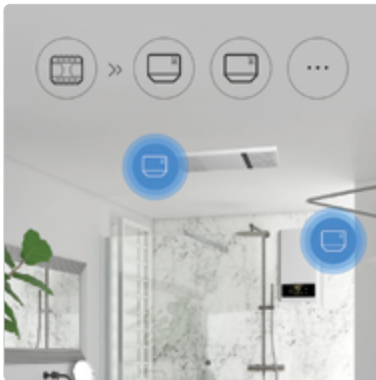

## S-MATE SWITCH

S-MATE can connect the ordinary 1/2/3-button wall switch which acts as a remote controller. After pairing with MINI R3, MINI R3 can be controlled locally by S-MATE through the “eWeLink-Remote” signal, and trigger other smart devices in the smart scene. 1 MINIR3 can connect more S-MATE, and 1 S-MATE can be added to 3 MINIR3.

S-MATE is battery-powered, so it does not require a neutral wire in the mounting box. S-MATE is fit for almost any switch type, such as pulse switch, rocker switch, and change your existing switch into a smart one.

SONOFF S-MATE is the module that can transmit the “eWeLink-Remote” signal, we also named it “eWeLink-Remote sub-devices”. MINI R3 is the device with “eWeLink-Remote” received, we name it “eWeLink-Remote gateway”. Once S-MATE was added to any eWeLink-Remote gateway (such as MINI R3, M5, B05-BL), can not only control all products with eWeLink-Remote gateway when there is no network connection locally but also controls any other SONOFF smart device in the smart scene when there is a network connection. It is “eWeLink-Remote” Control.

**CONTROL:** Control built-in “eWeLink-Remote gateway” devices when no Internet is available, and it can trigger other smart devices in the smart scene when there is a network connection.

### FUNCTION

- “eWeLink-Remote” Control: Use it with the MINI R3 or other smart switch with the gateway function of “eWeLink-Remote”, it can achieve “eWeLink-Remote” control.
- Compatible With Switch Types: S-MATE is fit for almost any switch type, like, pulse switch, rocker switch, change your existing switch into a smart one.
- Switch Mate: Works with MINI R3 smart switch, M5 smart wall switch, B05-BL LED Bulb and S40/ S40 LITE smart plug.

Download eWeLink Application.

Full info for the products, instructions can be found at [www.elmarkholding.eu](http://www.elmarkholding.eu)

### TECHNICAL DATA

- Input voltage: 100-240V AC, 50/60Hz
- Output current: Max 16A
- Power supply: 3V button cell x 1
- Battery type: CR2032
- Enclosure Material: PC V0
- Dimension (LxWxH): 51x44.5x24 mm

Catalogue number	Input voltage	Output current	Output power	Colour	Packing/Box (pcs)
S-MATE	100-240V AC	16A	3500W	White	1/100

Scan and watch detailed video with all product functions.



### MINI R3 & S-MATE

S-MATE can connect the ordinary 1/2/3-button wall switch which acts as a remote controller. It is battery-powered, so it doesn't require a neutral wire in the mounting box.



### S-MATE switch mate

Make your existing ordinary wall switch be a smart scene switch to control smart devices.



**3 YEARS TOTAL WARRANTY**  
+ 3 standard  
0 extended



**Cable-less connection**



**Easy mounting**  
Pasted with 3M adhesive or easily use by Magnetic attraction



**6-key free-wiring scene remote controller**  
Can be added to eWeLink gateway to control all devices in eWeLink APP using three trigger ways in Scene



## R5 SCENE CONTROLLER

When you have too many smart devices, and they are distributed in different rooms but don't want to control them through your phone? You need an R5 scene remote controller at this time, R5 can be added to the eWeLink-Remote gateway to control all devices in the eWeLink APP using three trigger ways in the scene.

SONOFF R5 is the module that can transmit the "eWeLink-Remote" signal, we also named it "eWeLink-Remote sub-devices". R5 scene remote controller can be added to the smart devices featuring the "eWeLink-Remote" gateway, like M5 smart wall switch, MNINI R3 smart switch and B05-BL smart LED bulb, can not only control all products with eWeLink-Remote gateway when there is no network connection locally but also controls any other SONOFF smart device in the smart scene when there is a network connection. It is "eWeLink-Remote" Control.

Use R5 with SONOFF M5 Switchman Smart Wall Switch, the same light can be controlled on both sides of the room even when M5 is offline. Never worry and spend time on two-way or multi-way control wiring. You can stick R5 on the wall as a switch, or take it off as a remote controller. One eWeLink-Remote gateway can add up to 8 R5 scene remote controllers!

### FUNCTION

- Scene Control: All SONOFF devices can be controlled by setting the smart scenes when the internet connection is available.
- "eWeLink-Remote" Control: Control the device which has the eWeLink-Remote gateway feature even offline, 90M remote control without Network.
- Multi Trigger Ways: Trigger the smart scene by clicking, double click, or long-press. Up to 18 trigger actions to set different scenes
- Two-way or Multi-way Control: Simple way to achieve two-way or multi-way control by eWeLink-Remote with M5 smart wall switch.
- Free-wiring Stick-on: Pasted with 3M adhesive or easily use by Magnetic attraction.

Note : SONOFF M5 smart switch and S40/S40 LITE smart plus are "eWeLink-Remote gateway, which can be used with R5 remote controller to realize two-way or multi-ways control without wiring even M5/MINIR3/B02-BL/B05-BL/S40/S40 LITE is off-line.

### TECHNICAL DATA

- Power supply: 3V button cell x 2 pcs
- Battery type: CR2032
- Colour: Dark grey
- Button QTY: 6
- Enclosure Material: PC V0
- Dimension (LxWxH): 86x86x13.5 mm

Download eWeLink Application.

Full info for the products, instructions can be found at [www.elmarkholding.eu](http://www.elmarkholding.eu)

Catalogue number	Power supply	Battery type	Colour	Packing/box (pcs)
R5	5V	CR2032	Dark grey	1/100



Scan and watch detailed video with all product functions.

### Local control by eWeLink-Remote

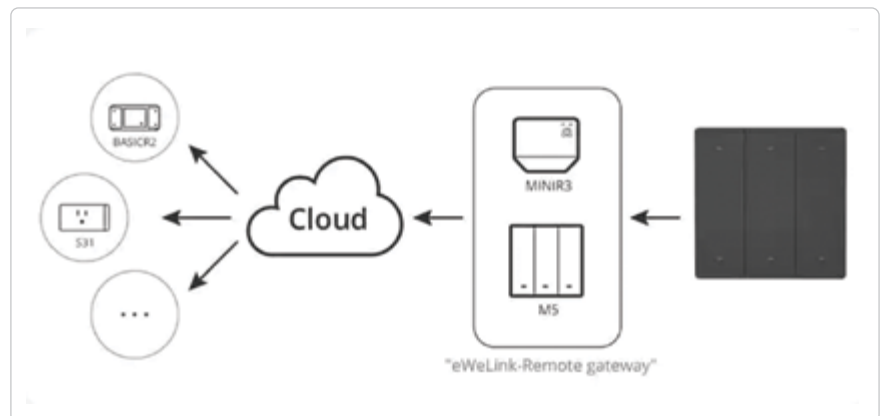

### Long battery life & Wireless stick-on

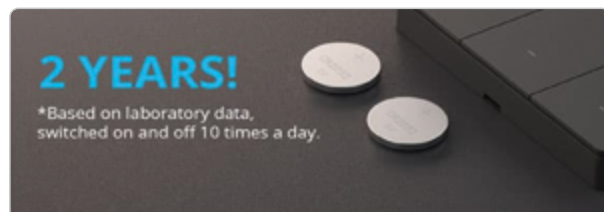

**3 YEARS TOTAL WARRANTY**  
+ 3 standard  
0 extended

## ONE CHANNEL WI-FI SMART SWITCH



One channel smart switch, remotely controllable via Internet and smartphone, Wi-Fi equipped, with timer function, 2200W (10A) peak output.

**CONTROL:** From anywhere via Smart device

### FUNCTION

- Safe And Reliable: ETL, CE, FCC, and RoHS certifications ensure a safer and more reliable product.
- Voice Control: Compatible with Amazon Alexa, Google Assistant, SmartThings, and Alice. Just speak out your command, the smart device can do on/off as you say.
- Easily DIY Your Smart Home Appliances: Connect directly to the middle of the power supply and the appliance to quickly make your ordinary appliances smart without buying a new smart one.
- Smart Scenes: Trigger other smart devices, make actions auto-on/-off. The appliances understand you, and your life becomes simpler.
- Fully Functional: By presetting timers or schedules on the eWeLink App, your USB LED light strips can be automatically turned on/off at a specific time. Automate your home appliances via different timing schedules, such as USB lamps, USB fan, USB water pump, etc

Arrange working time for devices

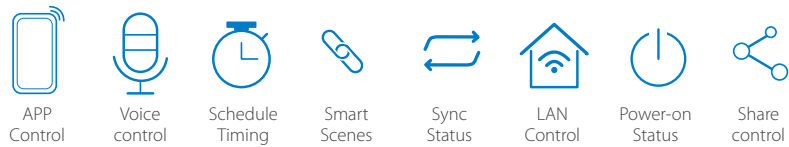

Download eWeLink Application.

Full info for the products, instructions can be found at [www.elmarkholding.eu](http://www.elmarkholding.eu)

### TECHNICAL DATA

- Input: 100-240V AC 50/60Hz
- Output: 100-240V AC 50/60Hz
- Max.Load: 10A/2200W
- Gang: 1
- Wi-Fi: IEEE 802.11 b/g/n 2.4GHz
- Material: PC V0
- Dimensions LxWxH: 90x41x27 mm
- Product weight: 58g

Catalogue number	Input voltage	Output current	Output power	Colour	Packing/Box (pcs)
195001	90-250V AC	10A	2200W	White	1/800

Scan and watch detailed video with all product functions.



Makes home appliances smart, ready to control your home from away

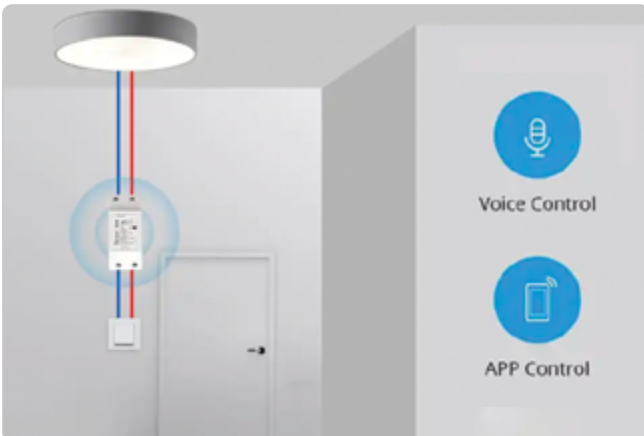

Manage a group of devices with a tap

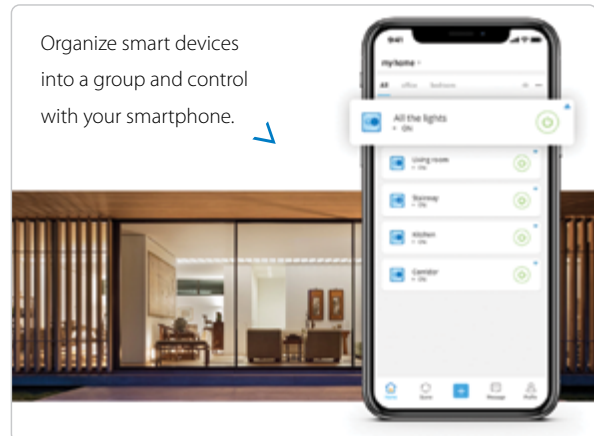

**3 YEARS TOTAL WARRANTY**  
+ 3 standard  
0 extended



## TWO CHANNEL WI-FI SMART SWITCH

Two channel smart switch, remotely controllable via Internet and smartphone, Wi-Fi equipped, with timer function, 2x2200W (2x10A) peak output.

**CONTROL:** From anywhere via Smart device

### FUNCTION

- Safe And Reliable: ETL, CE, FCC, and RoHS certifications ensure a safer and more reliable product.
- Voice Control: Compatible with Amazon Alexa, Google Assistant, SmartThings, and Alice. Just speak out your command, the smart device can do on/off as you say.
- Easily DIY Your Smart Home Appliances: Connect directly to the middle of the power supply and the appliance to quickly make your ordinary appliances smart without buying a new smart one.
- Smart Scenes: Trigger other smart devices, make actions auto-on/-off. The appliances understand you, and your life becomes simpler.
- Fully Functional: By presetting timers or schedules on the eWeLink App, your USB LED light strips can be automatically turned on/off at a specific time. Automate your home appliances via different timing schedules, such as USB lamps, USB fan, USB water pump, etc

### Arrange working time for devices



APP Control



Voice control



Schedule Timing



Smart Scenes



Sync Status



LAN Control



Power-on Status



Share control

Download eWeLink Application.

Full info for the products, instructions can be found at [www.elmarkholding.eu](http://www.elmarkholding.eu)

### TECHNICAL DATA

- Input: 100-240V AC 50/60Hz
- Output: 100-240V AC 50/60Hz
- Max.Load: 2x10A/2x2200W
- Gang: 2
- Wi-Fi: IEEE 802.11 b/g/n 2.4GHz
- Material: PC V0
- Dimensions LxWxH: 90x41x27 mm
- Product weight: 59g

Catalogue number	Input voltage	Output current	Output power	Colour	Packing/Box (pcs)
195004	90-250V AC	2x10A	2x2200W	White	1/800

Scan and watch detailed video with all product functions.



Makes home appliances smart, ready to control your home from afar



Manage a group of devices with a tap

Organize smart devices into a group and control with your smartphone.

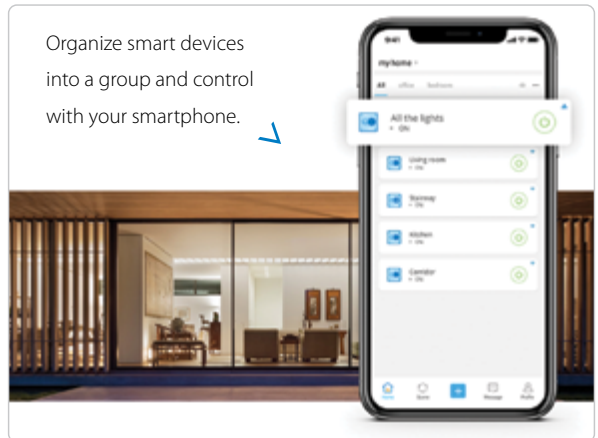

**3 YEARS TOTAL WARRANTY**  
+ 3 standard  
0 extended

## WI-FI DIY SMART RF CONTROL SWITCH



This is a WiFi Smart Switch with the DIY capability that makes it possible to control connected devices via the eWeLink directly from your phone, or ask it to turn on/off devices with Amazon Alexa and Google Assistant. Amazingly, it has a DIY mode that is the firmware can be user-defined. Built-in a web server that exposes the REST AP, which allows you to connect the switch with your existing home automation system. Compatible with HomeSeer, Home Assistant, etc, for the protocol document and the code for the DIY Mode tool.

RFR3 provides you extra control helper - the matched RM 433 remote controller. Just choose the control way you preferred, simply set a timer to let your devices switch on/off automatically at a pre-set time through a day. Compatible with the IFTTT function, and you can make more actions happen to trigger other devices, or receive a notification on your phone once the action was triggered.

Along with support for smart scenes, just set a device to turn on/off to make another or a boatload of devices turn on/off. The LAN control is designed for situations which no available Wi-Fi connection, or an unsteady Wi-Fi network environment. A convenient option that is share control is capable of allowing you to manage the same device with your family or friends together, simply share it on the eWeLink app to try. Amazingly, the module with unique DIY function, the way you can assemble it with your ordinary appliances to turn them into intelligent.

### Timer & Schedule

Single | Repeat | Countdown | Loop timer



**CONTROL:** From anywhere via Smart device

### FUNCTION

- Open Device REST API: Connect and control the RFR3 with your existing home automation system like Home Assistant via LAN.
- With 433MHz RF Control: Use your common 433MHz remote control to turn on/off the device without Internet.
- Voice Control: Compatible with Amazon Alexa, Google Assistant, SmartThings, and Alice. Just speak out your command, the smart device can do on/off as you say.
- Easily DIY Your Smart Home Appliances: Connect RFR3 directly to the middle of the power supply and the appliance to quickly make your ordinary appliances smart without buying a new smart one.
- Smart Scenes: Trigger other smart devices, make actions auto-on/-off. The appliances understand you, and your life becomes simpler.
- Fully Functional: RFR3 has all the most basic functions, like remote APP control, LAN control, smart scenes, timing schedule, share control, etc. Your best choice for the DIY switch etc.

**Sync status**  
Real-time device status can be provided on eWeLink App

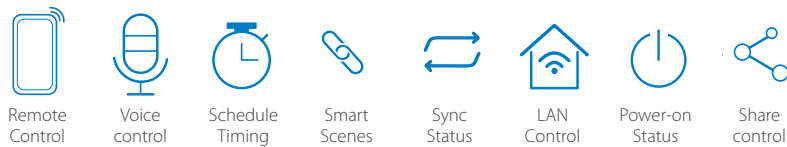
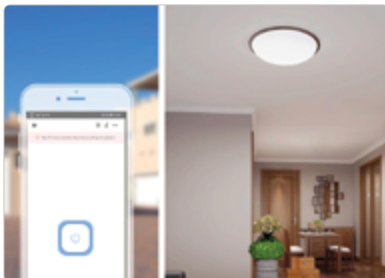

Download eWeLink Application.

Full info for the products, instructions can be found at [www.elmarkholding.eu](http://www.elmarkholding.eu)

Catalogue number	Input voltage	Output current	Output power	Colour	Packing/Box (pcs)
BASICRFR3	100-240V AC	10A	2200W	White	1/400

**3 YEARS TOTAL WARRANTY**  
+ 3 standard  
0 extended

Scan and watch detailed video with all product functions.



### TECHNICAL DATA

- Input: 100-240V AC 50/60Hz
- Output: 100-240V AC 50/60Hz
- Max.Load: 2x10A/2x2200W
- Gang: 2
- Wi-Fi: IEEE 802.11 b/g/n 2.4GHz
- Material: PC V0
- Dimensions LxWxH: 90x41x27 mm
- Product weight: 59g

### Compatible with IFTTT

Unlimited possibilities to control the devices

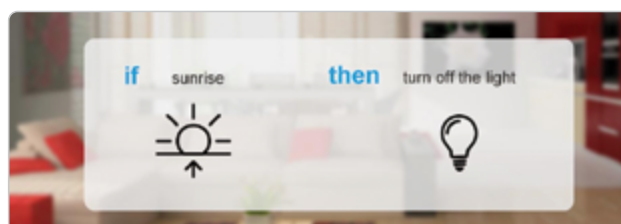
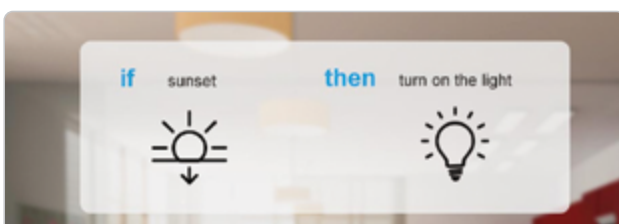



**Small and compact**



**Installation guide**

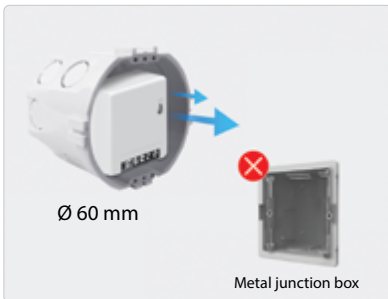

## TWO WAY SMART MINI SWITCH

MINIR2, as a reinforced MINI two-way DIY smart switch, has been redesigned to lift the safety and performance to the optimal level. The old version MINI has an external antenna with strong electricity, but the MINIR2's antenna is hidden totally into the interior that ensures you peace of mind to use it to control your devices. Additionally, the interface S1 and S2 are colored to gray which is distinguished from other input and output interfaces in order to further remind you not to connect the strong current to both of the interfaces. 2KV surge testing meets the 1KV surge testing standard that CE certification requires, and it passed the ANATEL certification, so MINIR2 give you enough safety to bring you a safe use experience. The small and compact smart switch is used for different kinds of switch boxes, even the smallest EU standard switch box. Convenient to automate your home appliances on eWeLink app with your smartphone or your voice command. Support 3 triggering modes that pulse mode (works with push button switches), edge mode (Works with SPDT switches) and following mode (Works with switches with "ON" and "OFF" mark and sensors with dry contact output). It supports the DIY mode (designed for developers) which allows users to integrate MINIR2 into worldwide third-party open source smart home control system to achieve LAN control without cloud service, such as Home Assistant, openHAB,ioBroker.

**CONTROL:** From anywhere via Smart device

### FUNCTION

- Two-Way Control: Use MINIR2 to retrofit a light and hide it in the switch box, without any traces. You will get a smart light and the physical switch controlling is still retained.
- Voice Control: Compatible with Amazon Alexa, Google Assistant, SmartThings, and Alice. Just speak out your command, the smart device can do on/off as you say.
- Open Device REST API: Connect and control the MINIR2 with your existing home automation system like Home Assistant via LAN.
- Smart Scenes: Trigger other smart devices, make actions auto-on/-off. The appliances understand you, and your life becomes simpler.
- Fully Functional: MINIR2 has all the most basic functions, like remote APP control, LAN control, timing schedule, share control, etc. Your best choice for the DIY switch.



APP Control



Voice control



Schedule Timing



LAN Control



Power-on Status

DIY

DIY Mode

MINI

Small Body

Download eWeLink Application.

Full info for the products, instructions can be found at [www.elmarkholding.eu](http://www.elmarkholding.eu)

### TECHNICAL DATA

- Input: 100-240V AC 50/60Hz
- Output: 100-240V AC 50/60Hz
- Max.Load:10A/2200W
- Wi-Fi: IEEE 802.11 b/g/n 2.4GHz
- Material: PC VO
- Dimensions LxWxH: 42.6x42.6x20 mm

Catalogue number	Input voltage	Output current	Output power	Colour	Packing/Box (pcs)
MINIR2	100-240V AC	2x10A	2x2200W	White	1/400

Scan and watch detailed video with all product functions.



Get your house lighted via your smartphone

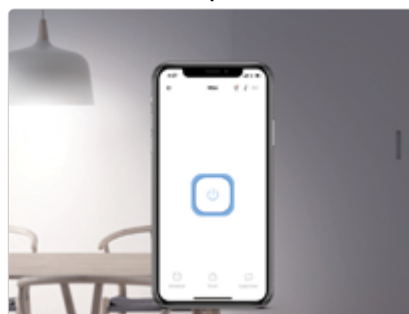

Customize smart scenes On/Off time, it's up to you

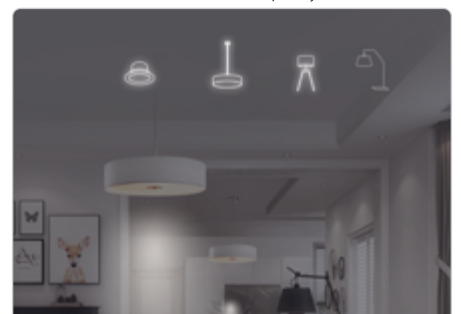





## SMART DIMMER SWITCH

New D1 smart dimmer switch excellently improves the lighting system in your home with different brightness levels. Turn on/off, brighten and dim the incandescent light bulbs and dimmable LED lights through the RM433 remote controller, eWeLink APP, Alexa or Google Home. The newly added sunrise and sunset mode are available in smart scene to activate your light when sunsets and inactivate it when sunrises. Amazingly, timing schedule and brightness setting can be enabled simultaneously in smart scene. It means that you can schedule the bed-room light to automatically turn on at 40% brightness at 7:00 AM and turn off at 100% brightness at 7:00 PM.

**CONTROL:** From Anywhere via Smart Device or by remote control

### FUNCTION

- **Stepless Dimmable:** Set the dimming range you want and adjust the light steplessly at any time. Support to dim incandescent light bulbs and dimmable LED light
- **Open Device REST API:** Connect and control the D1 with your existing home automation system like Home Assistant via LAN. Set up scenarios with different light intensities.
- **Sunrise & Sunset Scenes:** Keep track of the sun rise and set time of your location, so you can create a scene that activates at a fixed time, when the sun rises or when the sun sets.
- **RF 433MHz Remote Control:** Even easier dimming at hand, turn the light down casually with the RF 433MHz remote controller RM433 at the thrilling movie night, or on/off the light, enjoy an immersing moment
- **Adjust Party Ambience with Your Voice:** Turn up/down the brightness level light with your voice command for a great atmosphere via Amazon Alexa & Google Assistant.



Smart Dimming



Remote Control



RF Control



Voice control



Schedule Timing



Share control



Smart Scenes



Power-on Status

Download eWeLink Application.

Full info for the products, instructions can be found at [www.elmarkholding.eu](http://www.elmarkholding.eu)

### TECHNICAL DATA

- Input: 100-240V AC 50/60Hz
- Output: 100-240V AC 50/60Hz
- Max. Current: 1A
- Incandescent bulb: 200W
- Dimmable LED: 150W
- RF: 433.92MHz
- Wi-Fi: IEEE 802.11 b/g/n 2.4GHz
- Material: PC V0
- Dimensions LxWxH: 62x47x32.5 mm

Catalogue number	Input voltage	Output current	Output power	Colour	Packing/Box (pcs)
D1	100-240V AC	1A	200W	White	1/200

Scan and watch detailed video with all product functions.



### Set the brightness for the preset time



### Adjustable in 4 lighting levels



### Dim light on the right level via eWeLink App



**3 YEARS TOTAL WARRANTY**  
+ 3 standard 0 extended





## WI-FI SMART POWER METER SWITCH

This is 16A WiFi smart light switch that allows you to remotely manage and control your appliances and monitor your home energy usage. The WiFi light switch works like a power monitor, which allows you to keep track of 99% accurate real-time current, voltage and power on your app.

**CONTROL:** From anywhere via Smart device

### FUNCTION

- Remote Control –Turn electronic devices on/off from anywhere
- Monitor Energy Usage –Keep track of live power, current and voltage of your appliances on App
- Historical Energy Consumption –100-day daily/monthly energy usage data and total electricity cost
- Overload Protection –Set power, current and voltage threshold values to let appliances auto-off
- Measure Power Usage for a Period –Measure your appliances' power consumption for a specified time
- Sync Status–Real-time device status provided to App
- Timing Function –Supports 8 enabled scheduled/countdown timers
- Share Control –Invite your family to control your smart home together
- Scene–Turn on/off a gang of devices with one tap or triggered on/off by another smart device
- Smart Scene–Triggered on/off by temp, hum or other environmental conditions from a sensor
- APP Supported –Free iOS and Android eWeLink app
- Compatibility –Works perfectly with Amazon Alexa, Google Assistant, IFTTT, Google Nest

### Set timers

Set a timer to turn appliances On or Off



Remote Control



Voice control



Schedule Timing



Smart Scenes



Sync Status



Share control



Power Metering



Overload Protection

Download eWeLink Application.

Full info for the products, instructions can be found at [www.elmarkholding.eu](http://www.elmarkholding.eu)

### TECHNICAL DATA

- Input: 100-240V AC 50/60Hz
- Output: 100-240V AC 50/60Hz
- Max.Load: 16A/3500W
- Wi-Fi: IEEE 802.11 b/g/n 2.4GHz
- Material: Fire-retardant ABS V0
- Dimensions LxWxH: 114x52x32 mm
- Product weight: 91g

Catalogue number	Input voltage	Resistive current	Resistive load	Colour	Packing/Box (pcs)
195003	90-250V AC	16A	3500W	White	1/800

Scan and watch detailed video with all product functions.

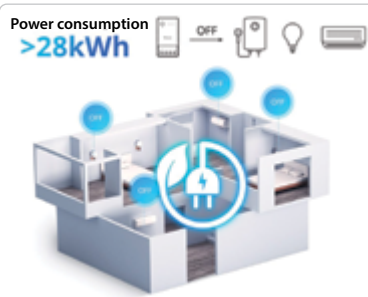

### Calculate power consumption

You can find savings by checking daily, monthly and yearly cumulative power consumption. Date dashboard shows real power.



**3 YEARS TOTAL WARRANTY**  
+ 3 standard  
0 extended



## TWO WAY SMART MINI POWER METERING SWITCH

DUALR3 is a flush-mounted Wi-Fi smart dual relay switch module that is installed behind any standard switch to transfer it into a smart switch for wireless remote control with mobile devices or voice command. Unifying your home appliances into an integrated wireless network to make them communicate with one another which is convenient for you to manage and control, including lights, home appliances and motorized facilities like roller shutters, window shades, blinds, awning, etc.

Three working modes available. DUALR3 comes with switch mode, motor mode and meter mode. One of the typical features is roller shutter and window shades smart control in the motor mode. The switch module offers the ultimate flexibility for your roller shutter and window shades by app remote control and scheduling timed events no matter whether you are home or away. Double two-way control. The double relay switch module distributes the load to two inputs compared to the simple relay, which this working mechanism lets you have two-way control for two devices independently.

**CONTROL:** From anywhere via Smart device

### FUNCTION

- Roller Shades Motor Control: Let your electric curtains, roller blinds, etc. become smart immediately.
- External Switch Two-Way Control: DUALR3 has 6 types of external switch detection mechanisms, making it suitable for most physical switch control
- Power Metering: The 2-Gang detects voltage, current, and power values and counts the power consumption for you independently to allow for reasonable energy consumption control.
- With The Most Features: DUALR3 has three working modes that meet the needs of different application scenarios. Remote, timing, voice control, smart scenes, and other functions are all available.
- Safe And Reliable: TUV, CE, FCC, and RoHS certifications ensure a safer and more reliable product.

### Double Two-Way control of lifts



APP Control



Voice control



Schedule Timing



LAN Control



Double Two-Way Control



Power Metering



Overload Protection

Download eWeLink Application.

Full info for the products, instructions can be found at [www.elmarkholding.eu](http://www.elmarkholding.eu)

### TECHNICAL DATA

- Input: 100-240V AC 50/60Hz
- Output: 100-240V AC 50/60Hz
- Resistive Load: 10A/2200W Gang; 3300W/15A Total
- Motor Load: 10-240W / 1A
- Wi-Fi: IEEE 802.11 b/g/n 2.4GHz
- Mounting: On DIN-Rail
- Material: PC V0
- Working temperature: from -10°C to 40°C
- Dimensions LxWxH: 54x49x24 mm

Catalogue number	Input voltage	Resistive current	Resistive load	Colour	Packing/Box (pcs)
DUALR3	100-240V AC	2x10A	2x2200W	White	1/400

Scan and watch detailed video with all product functions.



### Demo wiring diagram

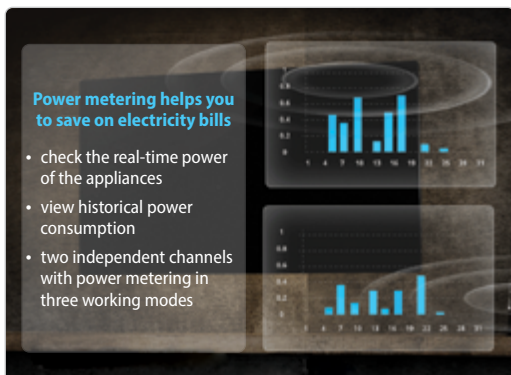
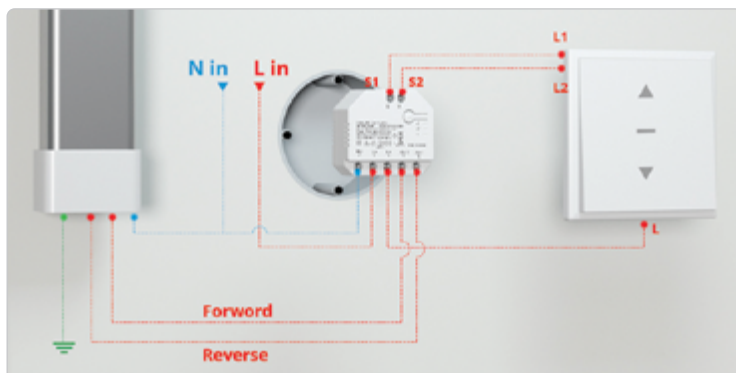

### Power metering helps you to save on electricity bills

- check the real-time power of the appliances
- view historical power consumption
- two independent channels with power metering in three working modes



## SMART WIFI POW ELITE POWER METER SWITCH, 16A

**CONTROL:** Local or from Anywhere via Smart Device

POW Elite can track your appliances power, current, and voltage in real-time and cumulative power consumption. POW Elite support to check 6-Month power consumption historical data accurate to the hour, the data can be exported to excel on your phone. You can set daily/monthly power consumption thresholds when the consumption goal is reached, you will get a push notification. Support adding SONOFF devices to Home Assistant for control and automation through the eWeLink add-on. To better help you save energy usage, POW Elite joins Alexa Energy Dashboard, you can centrally view the overall or individual device energy consumption in the dashboard. If you subscribe eWeLink Advanced plan, POW Elite is also compatible with IFTTT and eWeLink Web control. POW Elite with the highest flame-retardant grade V-0 enclosure, upgraded terminal wirings, and more amounts of tin minimize every security risk detail.

### FUNCTION

- LCD Screen: Track of power, current, voltage, and cumulative power consumption of your appliances in real-time on the LCD screen.
- 6-Month Consumption History Data by Hours: Power consumption data (accurate to hours) can be kept for up to 6 months which can be exported to excel on your phone.
- Overload Protection: You can set power, current, and voltage threshold. Once any condition is met, the POW Elite will be turned off to protect your appliances.
- Fully Functional: POW Elite has all the most basic functions, like App control, voice control, LAN control, timing schedule, inching setting, power on state, etc.



### TECHNICAL DATA:

- Input voltage: 100-240VAC 50/60Hz
- Output current: 16A
- Wireless Standard: 802.11 b/g/n
- Enclosure Material: PC V0
- Mounting: on DIN-Rail
- Dimension (LxWxH): 98x54x31 mm

Download eWeLink Application.

Full info for the products, instructions can be found at [www.elmarkholding.eu](http://www.elmarkholding.eu)

**3 YEARS TOTAL WARRANTY**  
+ 3 standard  
0 extended

Scan and watch detailed video with all product functions.



Catalogue number	Input voltage	Output current	Output power	Packing/Box (pcs)
THR316D	100-240VAC	16A	4000W	1/100

### 6-Month Consumption History Data

Automatically saves your consumption data when you remove the appliances or there is a power failure.



### Voice control

Works perfectly with Amazon Alexa, Google Assistant, IFTTT



**Sends notification when the set consumption is reached**



### Set timers

Set a timer to turn appliances on or off





## HIGH POWER SMART SWITCH WITH POWER MONITORING

POWR3 is a high power smart switch that can make your high-powered devices smart, or act as a smart meter for a single room, connecting all the appliances in the room to the POWR3 and the power consumption of each room is counted individually. From anywhere you'll be able to see which devices are turned on, it doesn't just visually communicate how much electricity you're using, it also stores your historical energy consumption for 100 days, which can be exported to CSV on your phone.

POWR3 lets you turn electronics on or off from anywhere with your smartphone using the eWeLink app or by simply giving voice commands to Amazon Alexa or Google Home Assistant. It also can turn devices on or off according to a schedule you choose. Multiple POWR3 can be controlled centrally, and the metadata and power consumption can be displayed on Hass through eWeLink add-on. Apart from that, overload protection can keep your electricity safe at all times once an abnormality was detected, the power will be cut off to avoid device damage and danger. What's more, to better help you save energy usage, POWR3 supports Alexa smart energy, you can centrally view the overall or individual device energy consumption in the Alexa Energy Dashboard. Use the POWR3 to automate your home while saving energy!

**CONTROL:** From Anywhere via Smart Device

### FUNCTION

- **25A/5500W Highest Output Power:** POWR3 has the highest output power to make your high-powered devices smart, or as a single room-meter to measure power consumption
- **Measuring Power Consumption:** Keep track of active power, current and voltage of your appliances on App
- **Overload protection:** Once an abnormality was detected, the power will be cut off to avoid device damage and danger.
- **One-tap switch on/off remotely:** POWR3 can cut off power wherever you are that can ensure the safety of your appliances and save on hidden electricity bills.
- **Voice Control:** Compatible with Amazon Alexa, Google Assistant, SmartThings, and Alice. Just speak out your command, the smart device can do on/off as you say.

### Metadata monitoring

Voltage | Current | Active power



APP Control



Voice control



Schedule Timing



LAN Control



Power Metering



Overload Protection

Download eWeLink Application.

Full info for the products, instructions can be found at [www.elmarkholding.eu](http://www.elmarkholding.eu)

### TECHNICAL DATA

- Input: 100-240V AC 50/60Hz
- Output: 100-240V AC 50/60Hz
- Max.Load: 25A/5500W
- Wi-Fi: IEEE 802.11 b/g/n 2.4GHz
- Material: Fire-retardant PC V0
- Dimensions LxWxH: 166x122x45.5 mm

Catalogue number	Input voltage	Output current	Output power	Colour	Packing/Box (pcs)
POWR3	100-240V AC	25A	5500W	White	1/100

Scan and watch detailed video with all product functions.



### Power metering for per room



### Cut off power wherever you are

POWR3 supports one-tap switch on/off remotely and synchronizes the switching status

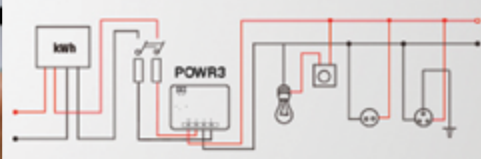



Main unit  
Cat. number:  
SPM-Main



4-Relay  
Cat. number:  
SPM-4Relay

## SMART POWER METERING, STACKABLE

Stackable Power Meter realizes smart management with overload protection, meta data monitoring and electricity statistics, support power-on state. The SPM-Main communicates with the cloud through Ethernet or WiFi, and communicates with the SPM-4Relays through RS-485, which allows for multi-terminal and stable long-distance data transmission and through the eWeLink App, you can obtain the power consumption.

Once the overload protection is enabled, you do not need to worry about electrical appliances being burned out, which helps remove potential safety hazards. In addition, you can also set the overload delay activated to avoid spurious triggering. One SPM-Main can be connected 32 SPM-4Relays. Each SPM-4Relay has 4 isolated channels to help the tenant to solve the problem in electric charge sharing. Each channel can support maximum current of 20A, no fear of high power load.

Get Over 180-day of Energy Usage Data Available SD card local storage. You can insert the SD card into SPM-Main to download and check over 180 days of your energy usage history at any time of the day through HTTP API.

**CONTROL:** From Anywhere via Smart Device or by remote control

### FUNCTION

- Connect up to 32 SPM-4Relays: One SPM-Main can be connected 32 SPM-4Relays. Each SPM-4Relay has 4 isolated channels to help you manage devices more conveniently.
- Max. 20A/Gang: Each channel can support maximum current of 20A, no fear of high power load.
- Overload Protection: Once the overload protection is enabled, it can protect your devices from burning out
- Micro SD: SD card plays a more significant role, like export electricity consumption data quickly, store more than 20 years of historical electricity consumption and each meter relay can save 20,000 operation logs.
- Power metering: Obtaining current, voltage, and power easily. You can monitor the consumption statistics of 4-Relay by checking eWeLink App on your mobile phone.

*Note : The Main Unit and 4-Relay of the Stackable Power Meter need to be used together. The Main Unit is connected to at least one 4-Relay to function.*

*Note 2: The Main Unit capacity supported 8-32GB SDHC card.*

**3 YEARS TOTAL WARRANTY**  
+ 3 standard  
0 extended

**3 YEARS TOTAL WARRANTY**  
+ 3 standard  
0 extended



**TECHNICAL DATA MAIN UNIT (SPM-MAIN)**

- Input voltage: 100-240VAC 50/60Hz
- Wireless Standard: 802.11 b/g/n, 2.4GHz
- Enclosure Material: PC V0
- Mounting: on DIN-Rail
- Dimension (LxWxH): 142.5x90x66.5 mm



**TECHNICAL DATA 4 RELAY (SPM-4RELAY)**

- Input/Output voltage: 100-240VAC 50/60Hz
- Input/Output Current: 4x20A
- Enclosure Material: PC V0
- Mounting: on DIN-Rail
- Dimension (LxWxH): 250x90x66.5 mm



**RS-485 COMMUNICATION ALLOWS FOR "SMART STACKABLE"**

The SPM-Main communicates with the cloud through Ethernet or WiFi, and communicates with the SPM-4Relays through RS-485, which allows for multi-terminal and stable long-distance data transmission.

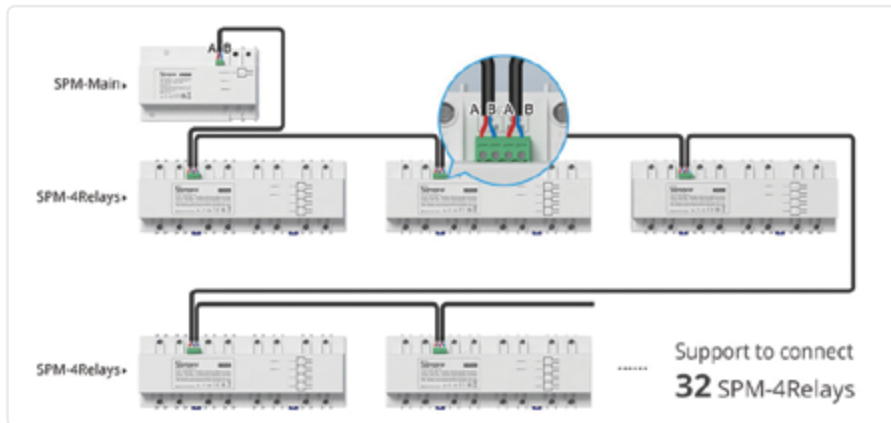

**SMART STACKABLE POWER METER**

This stackable power meter realizes smart management with overload protection, meta data monitoring and electricity statistic.



**128 ISOLATED CHANNELS & EACH UP TO 20A**

One SPM-Main can be connected 32SPM-4Relays. Each SPM-4Relays has 4 isolated channels to help the tenant to solve the problem in electric charge sharing





**Schedule the Uptime & Downtime**

Set a time/countdown for your ceiling fan with lights.

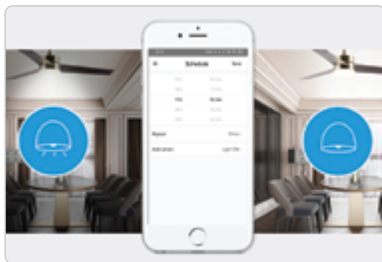

**WI-FI FAN AND LIGHT SMART SWITCH CONTROLLER**

iFan03 is a Wi-Fi ceiling fan and light controller supported to control the ceiling fan with light using your phone wherever you are. Voice control is designed to make you easily command iFan03 to turn on or off the fan and light, no need any manual operation. Support to control the ceiling fan with light from your phone wherever you are and whenever you want. Schedule for it to turn on and off at daytime or nighttime, or anytime throughout the day, and it will turn on or off automatically. Supplied with a RM433 remote controller where you can adjust the fan among the low, medium and high speed for getting different levels of cool feeling. The scenes feature in the app allows you to control one or multiple SONOFF devices, quickly and simultaneously with a single tap.

iFan03 comes with a 433 RF Remote, with whom you can turn on/off the fan and light, adjust fan speed indoors.

**CONTROL:** From Anywhere via Smart Device or by remote control

**FUNCTION**

- Direct Replacement: Simply replace your existing ordinary ceiling fan with lights controller with iFan03, you will immediately get a smart ceiling fan with lights
- APP&433MHz RF Remote Control: Through eWeLink App, you can remotely control the ceiling fan with lights with ease on iOS & Android smartphone anywhere and anytime. The device can be also controlled via the
- RM433 remote controller (included in the package). The small 433MHz remote controller design allows you to hang it on the wall as a wireless wall switch or remove it as a remote control as required.
- 3 Fan Speeds: The APP enables you to choose low, medium, and high fan speed to keep your room comfortable.
- Timer&Schedule: By presetting single, repeating, and countdown timers, the iFan03 WiFi Ceiling Fan&Light Controller can be automatically turn on/off at a specific time.

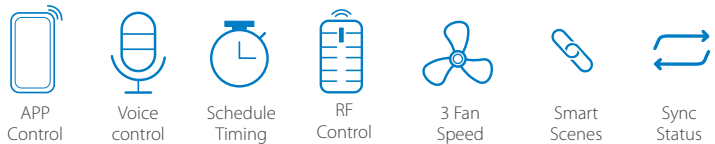

Download eWeLink Application.  
Full info for the products, instructions can be found at [www.elmarkholding.eu](http://www.elmarkholding.eu)

**TECHNICAL DATA**

- Input voltage: 100-250V AC
- Fan Output Voltage: AC100-240V 50/60Hz
- Fan Output Current: 2A
- LED Output: Max. 300W/220V
- RF Remote Control: 433.92MHZ
- Wireless Standard: 802.11 b/g/n
- Security Mechanism: WPA-PSK/WPA2-PSK
- Enclosure Material: Fire-retardant ABS V0
- Dimension (LxWxH): 116x55x26 mm

Scan and watch detailed video with all product functions.



Catalogue number	Input voltage	Output current	Output power	Colour	Packing/Box (pcs)
IFAN03	100-240V AC	2A	600W	White	1/100

**3 fan speed adjustable**

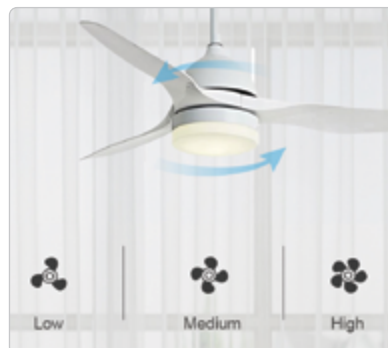

**Sync the run status**

Sync real-time working status to your phone

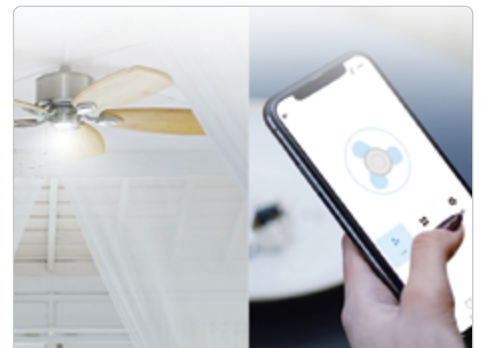

**3 YEARS TOTAL WARRANTY**  
+ 3 standard  
0 extended





## WI-FI FAN AND LIGHT SMART SWITCH CONTROLLER

iFan04-H is a Wi-Fi ceiling fan and light controller supported to control the ceiling fan with light using your phone wherever you are. Voice control is designed to make you easily command iFan04 to turn on or off the fan and light, no need any manual operation. Support to control the ceiling fan with light from your phone wherever you are and whenever you want. Schedule for it to turn on and off at daytime or nighttime, or anytime throughout the day, and it will turn on or off automatically. Supplied with a RM433 remote controller where you can adjust the fan among the low, medium and high speed for getting different levels of cool feeling. The scenes feature in the app allows you to control one or multiple SONOFF devices, quickly and simultaneously with a single tap. iFan04-H comes with a 433 RF Remote, with whom you can turn on/off the fan and light, adjust fan speed indoors.

**CONTROL:** From Anywhere via Smart Device or by remote control

### FUNCTION

- **Direct Replacement:** Simply replace your existing ordinary ceiling fan with lights controller with iFan04-H, you will immediately get a smart ceiling fan with lights
- **APP&433MHz RF Remote Control:** Through eWeLink App, you can remotely control the ceiling fan with lights with ease on iOS & Android smartphone anywhere and anytime. The device can be also controlled via the RM433 remote controller (included in the package). The small 433MHz remote controller design allows you to hang it on the wall as a wireless wall switch or remove it as a remote control as required.
- **3 Fan Speeds:** The APP enables you to choose low, medium, and high fan speed to keep your room comfortable.
- **Timer & Schedule:** By presetting single, repeating, and countdown timers, the iFan034-H Wi-Fi Ceiling Fan&Light Controller can be automatically turn on/off at a specific time.
- **Hands-free Voice Control:** SONOFF iFan04-H is compatible with Amazon Alexa ( Amazon Echo/ Echo Dot/Amazon Tap) and Google Home Assistant. It allows you to use your voice to control your ceiling fan with lights and enjoy a hands-free experience.

**Schedule the Uptime & Downtime**  
Set a time/countdown for your ceiling fan with lights.

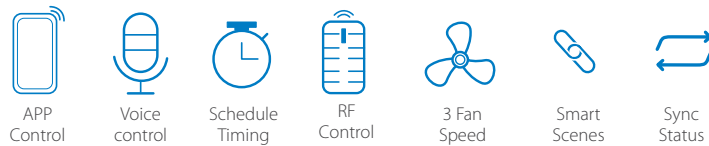

### TECHNICAL DATA

- Input voltage: 100-240V AC
- Fan Output Current: Max. 2A
- LED Output Current: Max. 3A
- RF Remote Control: 433.92MHz
- Wireless Standard: 802.11 b/g/n
- Security Mechanism: WPA-PSK/WPA2-PSK
- Enclosure Material: PC V0
- Dimension (LxWxH): 116x55x26 mm

Catalogue number	Output current	Output power	Colour	Colour	Packing/Box (pcs)
IFAN04-H	5A	690W	White	White	1/100

Scan and watch detailed video with all product functions.



### 3 fan speed adjustable

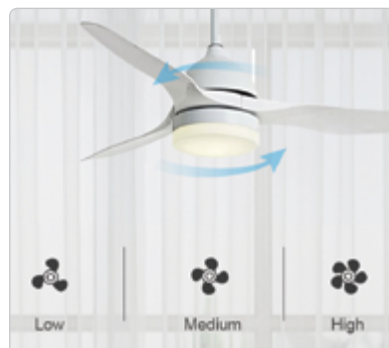

### Sync the run status

Sync real-time working status to your phone

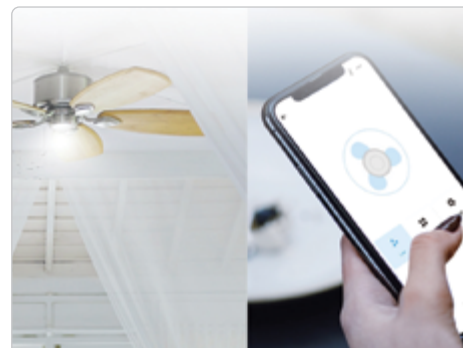

Download eWeLink Application.  
Full info for the products, instructions can be found at [www.elmarkholding.eu](http://www.elmarkholding.eu)



## TEMPERATURE AND HUMIDITY MONITORING WI-FI SWITCH

SONOFF TH Elite is a Smart Temperature and Humidity monitoring switch based on ESP32. With an LCD screen, TH Elite keeps monitoring the temperature and humidity in real-time, once they reach your preset threshold or the device's on/off state changes, you will receive the push notification on the phone. Support to connect 20A Max high load equipment like electric floor heating. You can replace your dry contact outputted traditional thermostat with TH Elite, to control the combi boiler or any other systems controlled by the ordinary switch. TH Elite support to review 6-Month Temp & Humidity historical data accurate to the hour. In the smart scene, temperature, humidity, on, off support setting as the trigger, on, off, invert as execute actions. Support adding SONOFF devices to Home Assistant for control and automation through eWeLink add-on. TH Elite turns your traditional thermostat into smart, automates your irrigation system, and gives you an easy way to monitor the temperature and humidity.

SONOFF TH Elite supports three kinds of temperature monitor and humidity monitor sensors—THS01 Temp & Humi Sensor, DS18B20 waterproof Temp sensor, and MS01 Soil Moisture Sensor. The sensor connector is upgraded to RJ9, supporting hot-plugging making the connection more stable and reliable.

The RL560 sensor extension cable can connect the SONOFF temperature and humidity sensors to extend your device's distance. THS01, DS18B20 can be extended to 60M, and MS01 Soil Moisture Sensor can be extended to 10M.

### ▼ eWeLink Web Control

More convenient to view and control multiple devices on web page.



### ▼ Supports IFTTT

Add IFTTT to achieve automation with other brands' devices.



Schedule Timing



Timer



Loop Timer



Share control



Inching Mode



Power-on Status



Switching Wi-Fi

**CONTROL:** Local or from Anywhere via Smart Device

### FUNCTION

- 20A Max & Dry Contact Output: Support to connect 20A Max high load, dry contact output.
- 6-Month Temp & Humidity Historical Data by Hours: Support to review the temp & hum history data by hour, day and month. Past 6-month history data can be exported in .xlsx format and accurate to hour.
- Local Automatic Control: Support LAN control, automatic control is more reliable. You can set 8 automatic control programs for you to save electricity bills and create comfortable surroundings.
- Voice Control and Query: Work with Alexa, Google Assistant, you can query temperature and humidity values by your voice.

**3 YEARS TOTAL WARRANTY**  
+ 3 standard  
0 extended

Download eWeLink Application.

Full info for the products, instructions can be found at [www.elmarkholding.eu](http://www.elmarkholding.eu)

### TECHNICAL DATA

- Input voltage: 100-240VAC 50/60Hz
- Output current: 20A
- Dry contact: 5-30V, 1A max.
- Wireless Standard: 802.11 b/g/n
- MCU: ESP32
- Enclosure Material: PC V0
- Mounting: on DIN-Rail
- Working humidity: 5-95%RH, non condensing
- Working temperature: from -10° to 40°C
- Dimension (LxWxH): 98x54x31 mm



Scan and watch detailed video with all product functions.

Catalogue number	Input voltage	Output current	Output power	Colour	Packing/Box (pcs)
THR320D	100-240VAC	20A	4800W	White	1/800



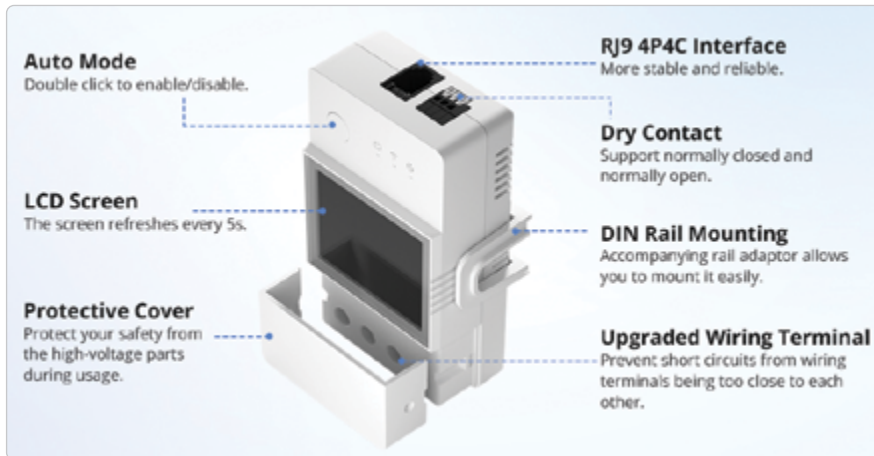

**Scene Automation**

Use with other smart devices to achieve automation

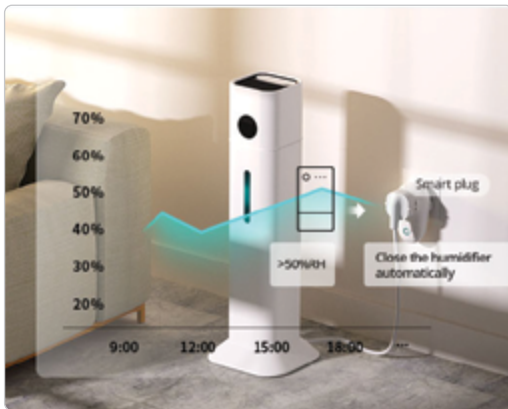

**Reliable Temperature & Humidity control**

Supports LAN control

**Auto mode**

- The device can turn On/Off automatically according to the temp. & humi. thresholds at different time periods.
- 8 automatic control programs for you to save electricity and create comfortable surroundings.

**Manual control**

Turn On/Off the devices on the App anywhere, anytime



**SENSORS:**

**TEMPERATURE & HUMIDITY SENSOR**

Catalogue number: THS01  
Working temperature: from -40° to +85°C  
Working humidity: 0-100%RH  
Connector type: Rj9 4P4C  
Cable length: 0.5m  
Max. extended length: 10m



**WATERPROOF TEMPERATURE SENSOR**

Catalogue number: DS18B20  
Working temperature: from -55° to +125°C  
Connector type: Rj9 4P4C  
Cable length: 0.5m  
Max. extended length: 60m



**SOIL MOISTURE SENSOR**

Catalogue number: MS01  
Working temperature: from 0° to +60°C  
Working humidity: 0-100%RH  
Connector type: Rj9 4P4C  
Cable length: 0.5m  
Max. extended length: 10m



**SENSOR EXTENDED CABLE**

Catalogue number: RL560  
Conductor resistance: max. 10Ω  
Connector type: Rj9 4P4C  
Cable length: 5m  
Max. extended length: 60m  
Insulation resistance: min. 5MΩ



**3 YEARS TOTAL WARRANTY**  
+ 3 standard 0 extended

## SMART WIFI FOUR CHANNEL SWITCH WITH RF CONTROL



Four gang Wi-Fi Smart Switch 4CHPROR3 is designed to give you the ability to integrate smart control into your home to enable it smart. Each smart switch has 4 gangs that can be used to control lights and other home appliances at the same time in four areas of your home. 4CHPROR3 is designed with an additional function for RF control. The function is purposely adopted to make you turn on/off the device connected with 4CHPROR3 via the RM433 remote controller. 4CHPROR3 have 3 working modes on eWeLink APP. So you can enable self-locking mode to turn on/off 4 connected devices separately, interlock mode to turn on 1 connected device every time and turn off the rest of devices simultaneously and inching mode to turn on 1 connected device and then make it turn off automatically after a given time (0.5 - 3600s). For the device away from the switch, you can create a movable space in virtue of a DIN rail to make them be connected. Simply activate devices through your voice when the switch works with Alexa and Google Home smart assistant.

**CONTROL:** From Anywhere via Smart Device or by remote control

### FUNCTION

- Independently/Mutual Control 4 Devices: Turn on/off the 4 connected devices separately in self-locking mode. Turn on 1 device but turn off the other 3 devices at the same time in interlock mode. Turn on the connected devices but automatically switch off after 0.5-3600s later in inching mode.
- Dry Contact: If your device does not need to be powered through the output of the 4CHPROR3, but only needs to use it as a smart switch to control the line on and off, the 4CHPROR3 is your best choice.
- With 433MHz RF Control: Use your common 433MHz remote control to turn on/off the device without Internet connection.
- Easy To Out-of-Reach Devices: Mounted on the guide rail, convenient to connect and control devices far from the switch.
- Works With Alexa & Google Assistant & SmartThings & Alice: You can directly ask Amazon Echo/ Echo Dot/Amazon Tap, Google Home to turn on/off your devices.



Remote Control



Voice control



Schedule Timing



Share control



Smart Scenes



Sync Status



Power-on Status

**3 YEARS TOTAL WARRANTY**  
+ 3 standard  
0 extended

Download eWeLink Application.

Full info for the products, instructions can be found at [www.elmarkholding.eu](http://www.elmarkholding.eu)

### TECHNICAL DATA

- Input voltage: 100-250VAC & 5-24VDC
- Output power: 4x2200W
- Output current: 4x10A
- Frequency: 2.4Ghz
- Working temperature: 0°C-40°C (32°F-104°F)
- Humidity: 5%-90%RH, Non-condensing
- Product size: L145xW90
- Mounting: DIN rail

Scan and watch detailed video with all product functions.



Catalogue number	Input voltage	Output current	Output power	Colour	Packing/Box (pcs)
4CHPROR3	100-240V AC	4x10A	4x2200W	White	1/100

### Run 4 devices separately

4CHPROR3 allows you to turn On or Off 4 connected lights independently

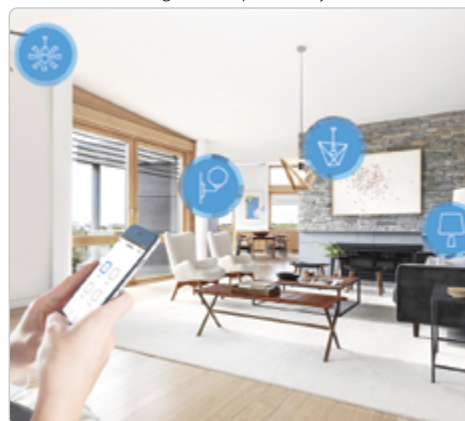

### Automate more devices

One channel controls one work status, enable interlock to turn on 1 channel and turn off other channels simultaneously

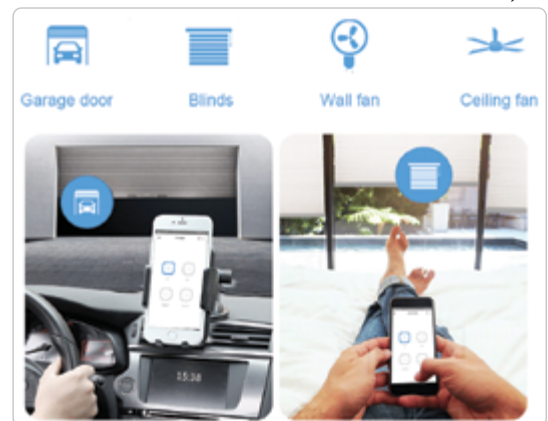









## SAVE VOLTAGE WIRELESS SMART HOME MODULE

SV is a low voltage switch. The low voltage light switch supports 5-24V power supply. Power supply separation enables it to control both AC and DC power. It has GPO reserved to support secondary development. This product does not have 433 RF function and shell.

SV low voltage WiFi switch is an affordable device that provides customers with smart home control. The low voltage WiFi switch is a WiFi based wireless switch that can connect to a wide range of appliances. Sonoff SV low voltage remote switch transmits data to a cloud platform through the WiFi router, which enables customers to remotely control all the connected appliances, via the mobile application eWeLink. The cloud server of Sonoff SV is Amazon AWS global server. SONOFF SV low voltage wireless remote switch makes all home appliances smart. As long as the mobile has network, customers can remotely control the appliances by turning them on off from anywhere at any time. Another feature available is to set timing schedules for the appliances, which can include countdown, scheduled on/off, and can thus, help customers maintain an easy life. The mobile application eWeLink enables customers to control the appliances easily. The iOS version of the application can be downloaded in App Store while the Android version in Google Play.

-  5~24V power supply voltage
-  Tracking device status and timely remote control through APP
-  Fast configure SSID and password through APP
-  Automatic connect to server, register and update status info
-  Setting max 8 single or repeat timing tasks each device
-  Numerous WiFi smart switches - One smartphone
-  Reserve GPO to support secondary development

### FUNCTION

- Remote ON/OFF: Turn electrical devices ON/OFF from anywhere
- LAN Control: Turn on/off the device even when Wi-Fi has no Internet access.
- Low Power Supply: 5-24V DC low voltage input
- App Support: Free iOS and Android mobile App eWeLink
- Sync Status: Real-time device status provided to App
- Timing: Set scheduled/countdown timers to turn ON/OFF at specified time
- Share Control: Control your smart home together with your family
- Scene: Turn ON/OFF a gang of devices with one tap
- Smart Scene: Triggered ON/OFF by temp, hum or other environmental conditions from sensor
- Compatibility: Works perfectly with Amazon Alexa, Google Assistant, IFTTT, Google Nest

Download eWeLink Application.

Full info for the products, instructions can be found at [www.elmarkholding.eu](http://www.elmarkholding.eu)

### TECHNICAL DATA

- Power supply: 3V button cell x 2 pcs
- Battery type: CR2032
- Colour: Dark grey
- Button QTY: 6
- Enclosure Material: PC V0
- Dimension (LxWxH): 86x86x13.5 mm

Catalogue number	Input voltage	Output current	Packing/Box (pcs)
SV	5-24V DC	1A	1

Scan and watch detailed video with all product functions.

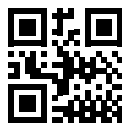

### Voice control with Amazon Alexa & Google Assistant



### Works with IFTTT

IFTTT helps your devices and apps work together in new ways

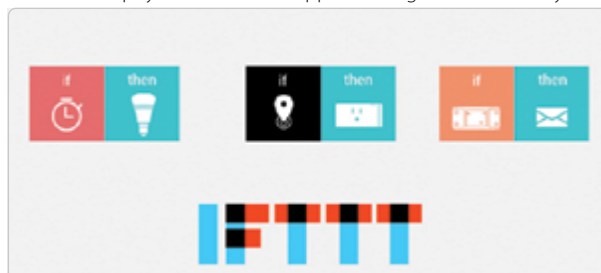

**3 YEARS TOTAL WARRANTY**  
+ 3 standard 0 extended



### WI-FI SMART CONTROL RELAY WITH BUILT-IN ANTENNA, ELR-1W

ELR-1W is widely used in smart homes and industrial intelligent control. It adopts the most popular Wi-Fi 2.4GHz control chip, and cooperates with powerful APP and mainstream voice assistants. Realize WLAN local control (even if the network is disconnected, you can also use APP local control and remote control, allowing users to fully experience the convenient life brought by modern intelligent technology. Using mobile phone APP or voice control device to control ON and OFF of the output of this product to realize the purpose of remotely starting or turning off the load electrical appliances.

The product cooperates with the corresponding APP to realize the following functions:  
Support Smart Config for fast networking.

Support multiple control types: switch, timing start and stop, cycle control, etc.

Support WLAN local control and remote control.

Access to mainstream voice assistants such as Tmall Genie, DuerOS, Xiao Ai (Xiao Mi), Alexa, Google, etc., voice control.

Intranet device sharing and cloud account device sharing function.

APP supports Android and iOS systems.

Build-in antenna

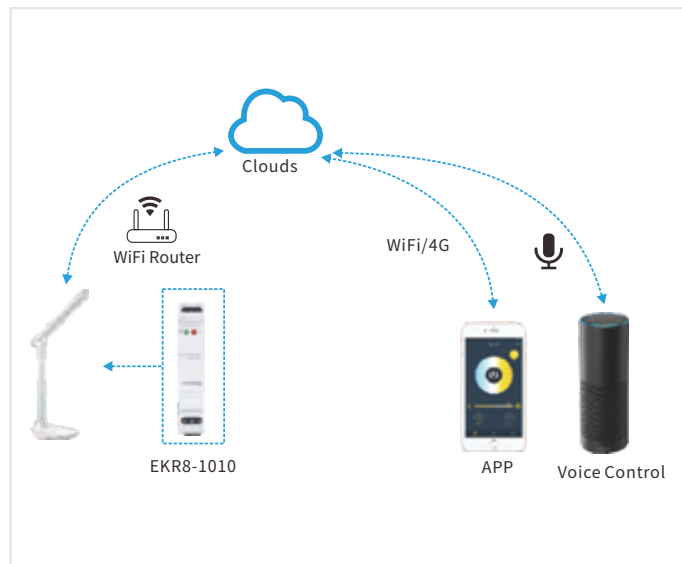

Structure block diagram of Intelligent control system

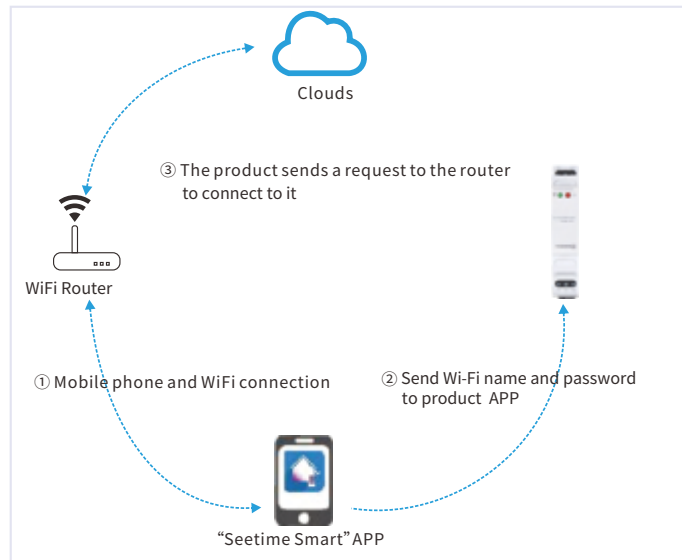

Distribution network block diagram of standard configuration

**5 YEARS TOTAL WARRANTY**  
+ 3 standard  
2 extended

**APPLICATION**

- Home control system
- Building automation
- Industrial control systems
- Industrial automation
- Mechanical and electrical equipment



**TECHNICAL DATA**

- Voltage Range: 85-240V AC/DC
- Rated Current: 10A
- Standard: IEEE 802.11b/g/n
- Working mode: STA/AP/STA+AP
- Wireless Security Support: WPA/WPA2
- Encryption Type: WEP/TKIP/AES
- Working Frequency: 2.4GHz-2.5GHz (2400M-2483.5M)
- Transmit Power:
  - > 802.11b (CCK): 19+/-1dBm
  - > 802.11g (OFDM): 14+/-1dBm
  - > 802.11n(HT20@MCS7): 13+/-1dBm
- Wireless Transmission Distance: General Indoor: 45M, Outdoor: 150M (Note: It depends on the environment)
- Application: Seetime Smart
- Standby Power Consumption: Less than 0.5W
- Working Temperature: -10-60°C
- Working Humidity: 5%-95% (Non-condensing)
- Size WxHxD: 18x90x65 mm

Catalogue number	Type	Dimensions (mm)			Packing/Box (pcs)
		W	H	D	
50150	ELR-1W	18	90	65	1/100

Scan and watch detailed video with all product functions.

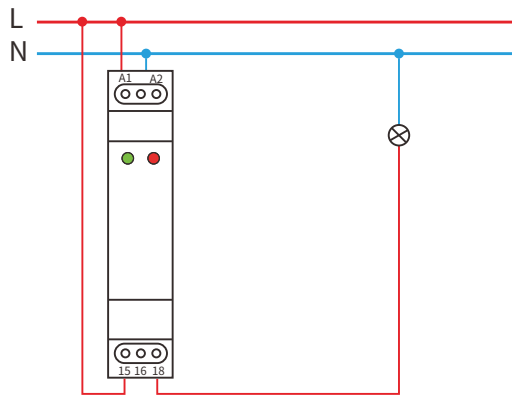
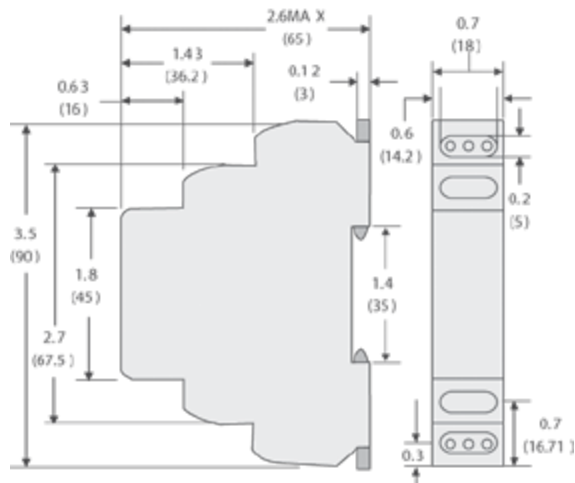

Product wiring diagram

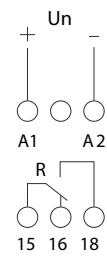

Wiring diagram

**5 YEARS TOTAL WARRANTY**  
+ 3 standard  
2 extended



### PIR MOTION SENSOR RF 433MHZ

PIR3-RF motion sensor can detect and report motion. When used for your home security system, it can detect the movement within 8M and help identify whether a human or pet is moving around inside your house, and your mobile phone will receive an alert notification. Connect SONOFF camera and you can view who is the intruder. When incorporated into your smart lifestyle, the sensor triggers your light on or off after connecting with SONOFF RF Bridge. You can set a scene that the hallway light is turned on when you enter the door.

With the universal joint, the sensor can be flexible to rotate a full 360°horizontal angle and 90°vertical angle which allows you to adjust the sensor into an optimal angle to view everything in your home (The sensor doesn't move on its own based on your motion). Another convenience for your home is that you can use the sensor for a position where the movement is not easy to be detected via mounting it in the universal joint, and just rotate the universal joint head to get a wonderful detecting angle. Plus, you can directly stick the sensor on the surface of objects to detect the movement. Just choose one as you like.

PIR3-RF has 2 working modes that alert and normal mode. In the alert mode, the sensor is triggered per 5s when someone enters the detection range. In the normal mode, the next alert trigger is activated if there is no motion detected within 1min after the previous detection

**CONTROL:** From Anywhere via Smart Device

#### FUNCTION

- Motion Sensor & Camera Binding: Alarm notification, by binding a camera, monitor your home on the double insurance.
- Alert Mode/Normal Mode: Two built-in modes which are two different trigger time mechanisms to meet your needs in different scenes.
- Smart Scenes: Set the smart scenes based on your needs, trigger more devices/scenes.
- Easy Installation: 3M adhesive or screw mounting (universal joint).

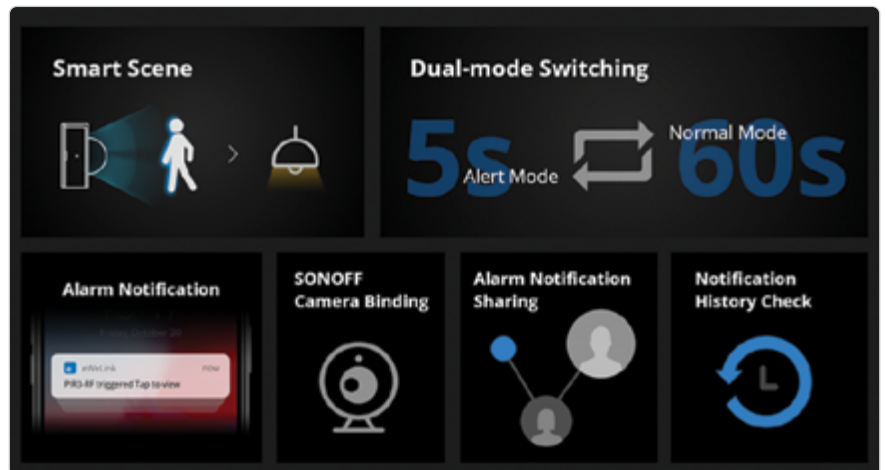

Download eWeLink Application.

Full info for the products, instructions can be found at [www.elmarkholding.eu](http://www.elmarkholding.eu)

#### 3M Adhesive for simple use

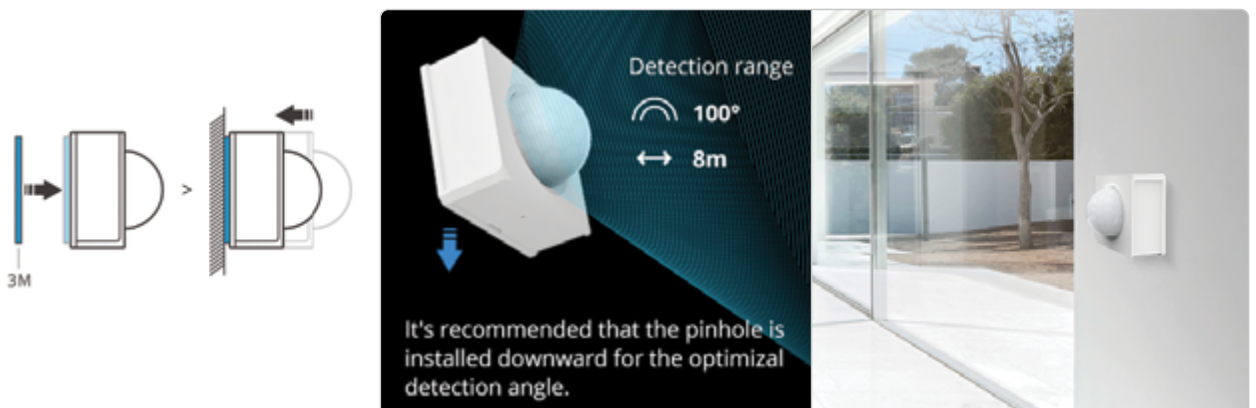

**3 YEARS TOTAL WARRANTY**  
+ 3 standard  
0 extended



**TECHNICAL DATA**

- Detection angle: 100°
- Detection distance: ≤ 8m
- RF: 433.92MHz
- Power supply: 3V button cell
- Battery type: CR2450 (not included)
- Working humidity: 10 - 90% (non condensing)
- Work temperature: from -10 to 40°C
- Enclosure Material: PC
- Dimension (LxWxH): 40x35x28 mm

Catalogue number	Detection angle	Detection distance	Battery	Packing/Box (pcs)
PIR3-RF	100°	≤ 8m	3V/CR2450	1/100

Scan and watch detailed video with all product functions.



**NOTE 1:** Works with RF bridge with catalogue number RFBRIDGER2.

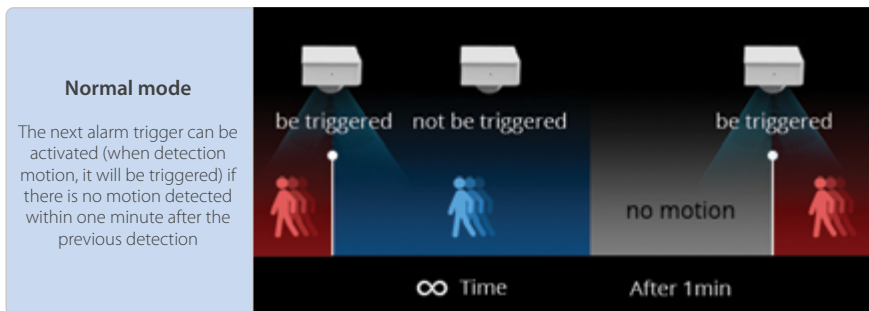
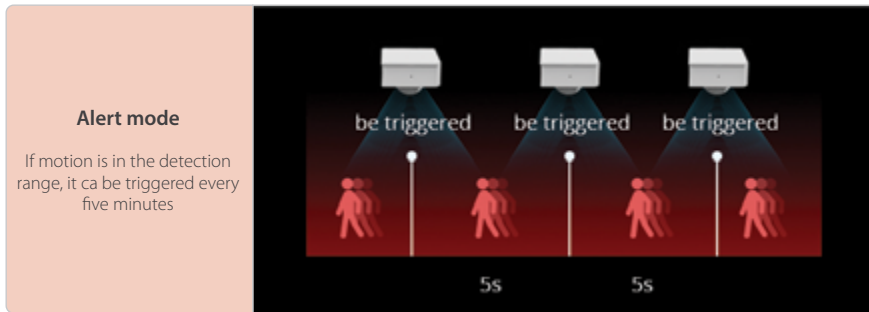
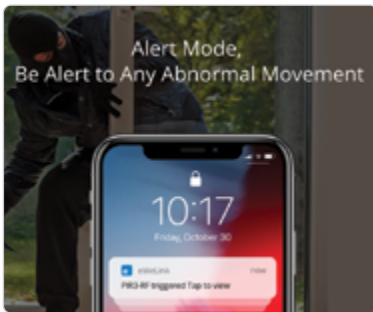

**Universal joint for flexible detection**

With the universal joint, can be realized 360° rotation detection. You can adjust the detection angle at any time to an optimum viewing level.

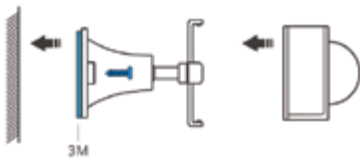

Cat. Number: PIR3-RFBASE

\* The universal joint is not included, please purchase it separately.

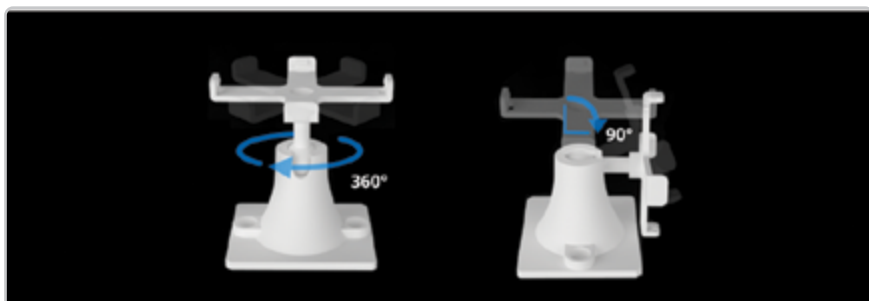

**3 YEARS TOTAL WARRANTY**  
+ 3 standard  
0 extended

## WIRELESS DOOR/WINDOW SENSOR

**CONTROL:** From Anywhere via Smart Device

### FUNCTION

- **No Gateway Needed:** The sensor is paired with App via Bluetooth and is controlled on App via WiFi.
- **Low-Battery Reminder & History Records Check:** There is a reminder on App about the low battery, and 3-month history records are automatically saved
- **Status Sync & Camera Binding:** Check the status of the sensor through App to get the real status. You can also add a camera to view.
- **Easy Installation:** With Simple peel and stick installation, it is easy to fit in door frames and window sills.

### TECHNICAL DATA

- Working Voltage: DC3V (2 x 1.5V battery)
- Quiescent current:  $\leq 40 \mu\text{A}$
- Emission current:  $<15\text{mA}$
- Operating systems: (Android 4.1 & iOS 9.0) or higher
- Wireless Standard: IEEE 802.11 b/g/n
- Installation gap:  $<5\text{mm}$
- Material: PC V0
- Size Magnet: 42 x 14 x 16 mm
- Size Transmitter: 70 x 31 x 19 mm



Scan and watch detailed video with all product functions.



Download eWeLink Application.

Full info for the products, instructions can be found at [www.elmarkholding.eu](http://www.elmarkholding.eu)

Catalogue number	Working voltage	Quiescent current	Emission current	Packing/Box (pcs)
DW2 WIFI	3V DC	$\leq 40 \mu\text{A}$	$<15\text{mA}$	1/600

Light up the hallway when you walk into the door

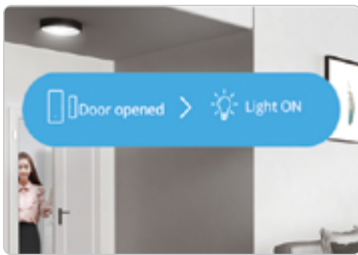

Light off when you walk out the door

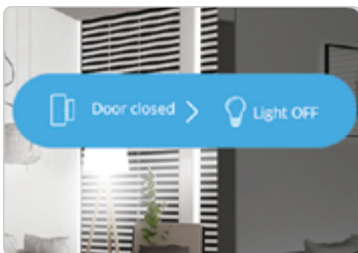

Sync Status	Alert Notification	Share control	No Gateway Required
Smart Scene	Low-battery Display	History record check	Bluetooth low energy pairing

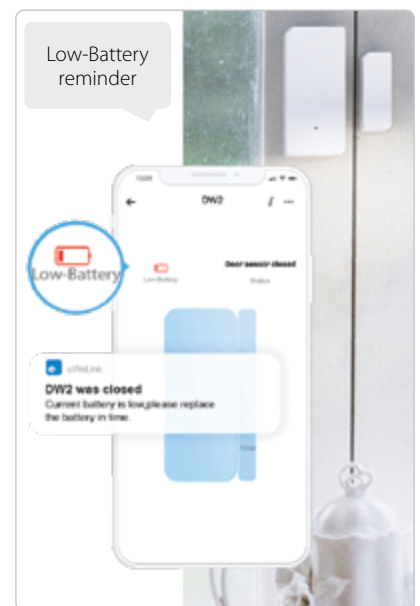
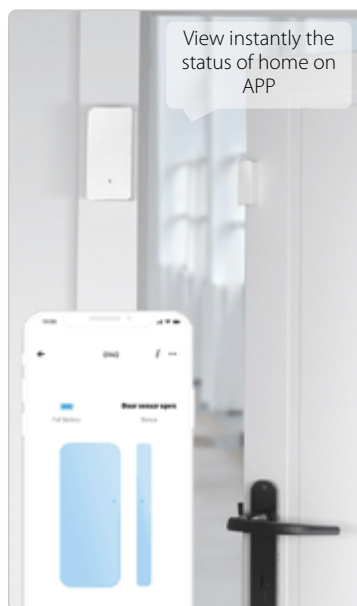

**3 YEARS TOTAL WARRANTY**  
+ 3 standard  
0 extended



## WI-FI SMOKE DETECTOR, TUYA SMART

This product is a smart photoelectric smoke sensor. It is a warning devices and can detect gas, heat or fire. Once detect danger of fire smoke, red LED will be ON and alarming to alert you and your family timely. It can be used in household, public work and any places witch needs alarm monitoring.

**MONITORING:** From Anywhere via Smart Device.

### FUNCTION

- Power ON status
- APP Control
- Alarming



APP Control



Power-on Status



Alarm & Recording

Download *TUYA Smart Application*.  
Full info for the products, instructions can be found at [www.elmarkholding.eu](http://www.elmarkholding.eu)

### TECHNICAL DATA

- Input voltage: 3V DC
- Battery: 2 x LR03
- Static current:  $\leq 15\mu A$
- Alarm current:  $\leq 160mA$
- Low voltage notification:  $\leq 2.4V$
- Alarm sound level: 80db / 1m
- WI-FI: 802.11 b/g/n
- Detecting range: 20m<sup>2</sup>
- Mounting: Ceiling
- Working temperature: from -10°C to +50°C
- Working humidity:  $\leq 95\%$
- Size (LxWxH): 70x24x18.5mm

Catalogue number	Input voltage	Alarm sound level	Detection range	Battery	Packing/Box (pcs)
46DS408	3V DC	80db	20m <sup>2</sup>	2 x LR03	1

Scan and watch detailed video with all product functions.



## WI-FI PLUG-IN GAS DETECTOR, TUYA SMART

This product is a smart flammable gas alarm, which is used to detect leakage of flammable gas and prevent the harm caused by gas leakage. This alarm uses high stability semiconductor gas sensor with small sensitivity drift. When a flammable gas leak is detected and the concentration value set by the alarm is reached, the alarm will send an alarm signal. This product is used indoor where leakage may occur, such as kitchens.

**MONITORING:** From Anywhere via Smart Device.

### FUNCTION

- Power ON status
- APP Control
- Alarming



APP Control



Power-on Status



Alarm & Recording

Download *TUYA Smart Application*.  
Full info for the products, instructions can be found at [www.elmarkholding.eu](http://www.elmarkholding.eu)

### TECHNICAL DATA

- Input voltage: 85-250V AC
- Average consumption:  $\leq 1.5W$
- Alarm sound level: 70db / 1m
- Alarm density: 7% LEL  $\pm 3\%$  LEI (CH4)
- WI-FI: 802.11 b/g/n
- Mounting: in socket
- Working temperature: from -10°C to +50°C
- Working humidity:  $\leq 95\%$
- Size (LxWxH): 48x30x55mm

Catalogue number	Input voltage	Alarm sound level	Alarm density	Packing/Box (pcs)
46DS409	85-250V AC	70db	7% LEL $\pm 3\%$ LEI (CH4)	1

Scan and watch detailed video with all product functions.





## SMART RGB LED STRIP CONTROLLER WITH REMOTE

The perfect solution to control RGB LED strips with a WiFi driver compatible with the eWeLink APP and voice assistants like Google Home or Alexa. Also includes a 24-key IR remote control. You will be able to turn on and control your strip lights anytime and anywhere and control them with a simple click on your smartphone or tablet via APP eWeLink or voice assistants, without time and distance limits. Discover all the possibilities it offers and give a touch of color to your home!

**CONTROL:** From Anywhere via Smart Device or by remote control.

### FUNCTION

- Remote control lights on/off from anywhere
- Free iOS and Android mobile App eWeLink
- The light changes colors and rhythmically flashes to match the beat of music, bringing you into a very joyful party.
- Point your mobile device's camera to anything to capture its color, tap the screen and instantly sync the color to your light.
- Several preset lighting scenes for your choice, so that it can meet your different lighting needs with one click.
- Compatibility –Works perfectly with Amazon Alexa, Google Assistant, Google Nest, so you can control Lights With Your Voice



Remote Control



Voice control



Time Schedule



Scene Mode



Share Control



Power on State

Full info for the products, instructions can be found at [www.elmarkholding.eu](http://www.elmarkholding.eu)

### TECHNICAL DATA

- Input voltage: 5-24V
- Output Current: 2A ( per way)
- Channel: maximum 4 RGB channels (way)
- Remote: 24 Key IR
- Material: ABS V0
- Size: 55x95x27 mm



Catalogue number	Input voltage	Output current	Channals	Packing/Box (pcs)
L2-C	5-24V DC	2A (per way)	4 RGB channels (way)	1/50

**3 YEARS TOTAL WARRANTY**  
+ 3 standard  
0 extended



## RF REMOTE CONTROLLER WITH FOUR BUTTONS

The RF Remote is a 433MHz Wireless 4 Buttons Push Cover Remote which RF remote controls the learning code wall switch, plug seat or extention socket. The RF controller fits for all those 433Mhz controlled devices. The wireless RF remote suitable for long distance and multiple switch control. This product can work with our smart home products: SONOFF RFR2, SONOFF SlampherR2, SONOFF 4CHPROR3, SONOFF RF Bridge 433, SONOFF TX.

### FUNCTION

- RF Remote Control: With 4 buttons, this RF remote controller is suitable for long-distance and multiple switch control.

Download eWeLink Application.

Full info for the products, instructions can be found at [www.elmarkholding.eu](http://www.elmarkholding.eu)

### TECHNICAL DATA

- Battery: 12V ( 27A)
- Wireless: 433MHz
- Material: PC V0
- Weight: 31g
- Size: 50 x 30 x 12 mm



Catalogue number	Working voltage	Battery type	RF	Packing/Box (pcs)
4KEY433REMOTEBAT	12V	27A	433MHz	1/500

## RM433R REMOTE CONTROLLER



Designed with 8 buttons to perform various functions in running on different types of devices. Such as fan speed adjustment, brightness setting, etc. The simple and stylish look gives any surface a beautiful decor when it is stored on the wall. Strong compatibility. It can be paired to control SONOFF RFR2, RFR3, Slampher2, iFan04, D1, TX series, 433 RF Bridger2 and other devices supporting 433 communication protocol and other devices supporting 433 communication protocol. Pairing with your devices is extremely simple and takes no time at all, simply press any button on the remote controller to pair with the device you need to control. Quick installation. Can match the base to be stored on the wall with double-sided 3M tapes or screws.

### FUNCTION

- Remote Control: Control the connected devices remotely.
- Powerful Compatibility: Suitable for devices supporting RF433MHz communication protocol.
- Easy To Pair & One-Key Pairing: Press any button to pair with devices, and Sonoff D1 and iFan03/iFan04 can match the whole controller with just a press.
- Smooth Touch & Easy Installation: Sleek and modern design and fast installation with 3M adhesive tape or screws.
- User-Definable: 8 buttons can match 8 devices as you defined.

### TECHNICAL DATA

- Working Voltage: 12V removable battery (Model: 27A)
- Number of keys: 8
- Material: PC V0
- RF: 433MHz
- Weight: 35g
- Size: 86 x 45 x 12,5 mm



Catalogue number	Working Voltage	Battery Type	RF	Packing/Box (pcs)
RM433WITHBATTERY	12V	27A	433MHz	1

Download eWeLink Application.

Full info for the products, instructions can be found at [www.elmarkholding.eu](http://www.elmarkholding.eu)

### Wide applications suitable for all devices with 433MHz

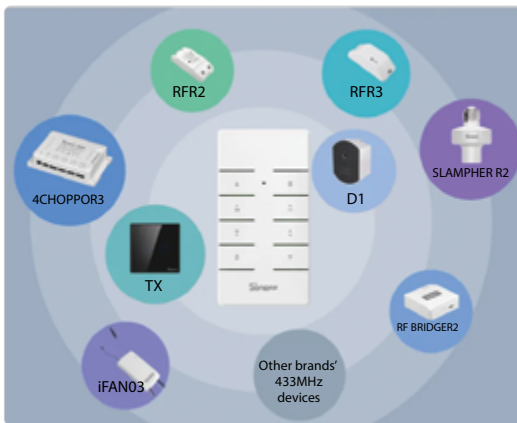

### Control your devices when there is no Wi-Fi connection



### 8 buttons can control 8 devices or more



**3 YEARS TOTAL WARRANTY**  
+ 3 standard  
0 extended

## DIN RAIL ADAPTOR FOR SMART SWITCHES

For easy installation of many Sonoff switches to DIN rail. DIN- Rail adaptor DR can work with most of SONOFF products, such BASICR2 / BASICR3, RFR2 / RFR3, POWR2, TH10 / 16, DUALR2.



Catalogue number: DR

### FUNCTION

- Allows you to install the smart switches to the DIN rail.

Full info for the products, instructions can be found at [www.elmarkholding.eu](http://www.elmarkholding.eu)

### TECHNICAL DATA

- Material: ABS V0
- Size (LxWxH): 112x52x10 mm

NOTE: SONOFF DR can work with most of our SONOFF products, including SONOFF BASICR2/ BASICR3, RFR2/ RFR3, POWR2, TH10/ 16, DUALR2.



### Can attach in to the DIN rail



### Easy installation



## IP66 WATERPROOF CASE

SONOFF IP66 is a high quality waterproof case that can be used with SONOFF BASICR2,RFR2 in the underwater environment. The waterproof level of the waterproof box is IP66. It allows you to remote control your lights or home appliances outdoor.



Catalogue number:  
WATERPROOFBOXIP66

### FUNCTION

- Water-Proof: IP66 waterproof rating means the housing has a robust waterproof capability. Ensure your devices use in a wet environment safely.
- Dust-Proof: Prevent your devices from dust entering.

Full info for the products, instructions can be found at [www.elmarkholding.eu](http://www.elmarkholding.eu)

### TECHNICAL DATA

- Material: ABS V0
- Transparent Cover Material: PC V0
- Waterproof Level: IP66
- Size (LxWxH): 132.2x68.7x50.1 mm
- Weight: 145g



### High Ingress Protection



### Easy installation



## SELF ADHESIVE NFC RFID STICKERS NTAG213- 10 PCS, SET

Compatible with all devices support NFC. NTAG213 chips have read and write locking functions, which can be repeatedly edited. Can be use them to quickly share your social information, music, connecting wifi, establishing smart homes, etc., making your life more colorful. You just need hover your phone over the NFC Sticker, data will send to your phone directly, No need internal energy, no need battery, no manual pairing.

\*Tags cannot be used on the metal surface and strong magnetic field.

### APPLICATION

- Set your alarm
- Quiet your phone
- Launch your navigation app
- Toggle your WI-FI ON/OFF
- Make a Call -Send SMS
- Launch An App
- Join a WiFi Network
- Bluetooth ON/OFF
- Send a Business Card
- Show a Message
- Trigger Media System
- Toggle Phone Settings
- Set An Alarm
- Change Ringer Or Music Volume
- Change Screen Brightness
- Share a Contact
- Show Address Or Location
- Connect To Car Systems
- Update Social Media: Foursquare, Facebook, Twitter, LinkedIn
- Open a Web Page

### TECHNICAL DATA

- Chip: Ntag213
- Base material: PET
- Antenna structure: Aluminum etching (AL 10um)
- Protocol: ISO/IEC14443-A
- Memory capacity: 144 bytes
- Operating frequency: 13.56MHz
- Work mode: Passive
- Read live: 100 000 times
- Save live: 10 years
- Anti-static property (ESD): 2000V
- Working temperature: from -20°C to 70°C
- Humidity: 90% RH (non-condensing)
- Chip diameter: 22mm

### CATALOGUE NUMBER:

195NTAG213/10



Scan and watch detailed video with all product functions.

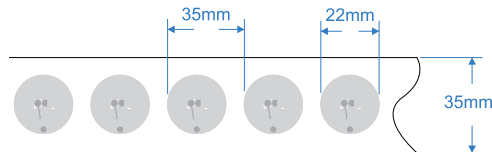

## SELF ADHESIVE NFC RFID STICKERS NTAG215- 10 PCS, SET

Compatible with all devices support NFC. NTAG215 chips have read and write locking functions, which can be repeatedly edited. Can be use them to quickly share your social information, music, connecting wifi, establishing smart homes, etc., making your life more colorful. You just need hover your phone over the NFC Sticker, data will send to your phone directly, No need internal energy, no need battery, no manual pairing.

\*Tags cannot be used on the metal surface and strong magnetic field.

### APPLICATION

- Send business V-card
- Set your alarm
- Quiet your phone
- Launch your navigation app
- Toggle your Wi-Fi ON/OFF
- Make a Call -Send SMS
- Launch An App
- Join a Wi-Fi Network
- Bluetooth ON/OFF
- Send a Business Card
- Show a Message
- Trigger Media System
- Toggle Phone Settings
- Set An Alarm
- Change Ringer Or Music Volume
- Change Screen Brightness
- Share a Contact
- Show Address Or Location
- Connect To Car Systems
- Update Social Media: Foursquare, Facebook, Twitter, LinkedIn
- Open a Web Page

### TECHNICAL DATA

- Chip: Ntag215
- Base material: PET
- Antenna structure: Aluminum etching (AL 10um)
- Protocol: ISO/IEC14443-A
- Memory capacity: 504 bytes
- Operating frequency: 13.56MHz
- Work mode: Passive
- Read live: 100 000 times
- Save live: 10 years
- Anti-static property (ESD): 2000V
- Working temperature: from -20°C to 70°C
- Humidity: 90% RH (non-condensing)
- Chip diameter: 30mm

### CATALOGUE NUMBER:

195NTAG215/10



Scan and watch detailed video with all product functions.



SMART LIGHT CONTROL



**WI-FI SMART LED BULB**

Smart LED bulbs are even smarter ones in home automation, and they are pretty easy to use. Simply screw the smart bulb into the lamp, pair it with your smartphone, and you will no more get up from your bed to hit the light switch.

Smart LED bulb allows you to dim and tune to different color temperature through sliding the bar on App. It has a wide brightness range that is from 2700K to 6500K, which is bright enough for almost any space for use. Works with the third-party smart assistants out there via support of Alexa and Google Home so you can control the bulb, adjust the brightness and color using your voice. The smart bulb with 9W can produce a 60-watt equivalent 806 lumens, reducing your monthly electricity bill significantly. Furthermore, it was reliable with time scheduling that makes the bulb automatically turn on and off at set time of day. The bulb also comes with eight optional preset scene modes that allow you to access instantly the ambient that you want to heighten. If you get multiple SONOFF smart LED bulbs, the group-control feature is quite convenient for you to turn on and off together, adjust all of color temperature and brightness to the same level through tapping on App.

**CONTROL:** From Anywhere via Smart Device or by Remote.

**FUNCTION**

- Remote Control: 16 million colors will make you feel relaxed and energized. Control it via your phone anywhere.
- Pick a Scene: 8 build-in modes, pick one according to your mood.
- Smart Scene: Customize scenes for your smart life, make the light ready when you open the door.
- Voice Control: Free your hands with Alexa/Google Assistant, just say out what you want.
- Rhythm Live: In the LAN, your smartphone MIC will recognize the music and up to 10 bulbs can change the colors with music rhythm, integrating the music into lighting.



App Control



Voice control



Smart Dimming

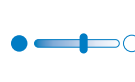

Tune colour temperature



Group Control



Scene Mode



Power Saving

Download eWeLink Application.

Full info for the products, instructions can be found at [www.elmarkholding.eu](http://www.elmarkholding.eu)

**TECHNICAL DATA**

- Input voltage: 220-240V AC
- Power: 9W
- Lumen: 806lm
- Colour Temp.: CCT 2700-6500K (adjustable)
- CRI: ≥Ra80
- For lamp holder: E27
- Wireless Standard: IEEE 802.11 b/g/n
- Material: PC V0
- Working humidity: 10 - 90% (non condensing)
- Work temperature: from -10 to 40°C
- Enclosure Material: PC
- Dimension (LxWxH): 60x60x112 mm

Scan and watch detailed video with all product functions.



Catalogue number	Input voltage	Power	Lumens	Colour temperature	Packing/Box (pcs)
BL05-BL-A60	220-240V AC	9W	806 lm	CCT	1/100





## AMBIENT LIGHT WITH WIRELESS SPEAKER



Cat. number:  
99AL4015



### FUNCTION

- Bluetooth sound
- TF storage card
- Ligting: 15 RGB modes

### TECHNICAL DATA

- Input voltage: DC5V / 5W
- Power: 5W
- LED light: SMD 5050 x 4pcs
- Speaker: 4Ω / 3W
- Noise ratio: 75db
- Battery: 500mAh
- Transmision distance: till 25m
- Frequency response: 100Hz-20KHz
- Work time: 3h
- Material: ABS
- Colour: Black
- Size: 80x80x62mm



**2** YEARS TOTAL  
WARRANTY  
+ 2 standard  
0 extended

SMART LED STRIPS

SMART WIFI L2 RGB LED STRIP



RGB LED Strip L2 can be used not only for the festival decorations but also for the additional lighting. No need to bother about spending more money on rewiring. With IP65 waterproof and 30 LEDs on every 3.3 feet, you can install L2 light strips around your swimming pool to light your home up. The 3M adhesive makes your installation with ease. More than 16 million colors and real-time synchronization provide a zestful experience for your life. The real time data of R/G/B helps you capture the light strip's status. Except for R/G/B data bars, the color palette, color circle, recent and classic color provide various selecting methods for color changing. There are 21 recommended scene modes and up to 8 DIY Scenes. L2 can sync to any playing music and dance along to rhythm and beat. No need to worry about the disconnecting anymore, BLE control helps you better control the light strip. Voice control with Alexa and Hey Google can help free your hands. Setting a timer help you turn on/off the light strips on schedule.

**CONTROL:** Local or from Anywhere via Smart Device

**FUNCTION**

- Diverse Selection Methods: Color palette, color circle, recent and classic color, various selecting ways for color changing. Enjoy the endless variations and real-time synchronization, more than 16 million colors.
- Smart scenes: 21 recommended scene modes and up to 8 DIY scenes, define your own scene to better adapt your surrounding.
- Work With The Sensor: Customize the scene and create an atmosphere when you at home.
- Adjustable Brightness/Color in Scene: Not only turns on the light at any time, but also adjust the brightness, color temperature, and color in the Scene
- IP65 Waterproof: High flexibility, feel free to cut and stick with ease. Note: WiFi Controller is non-waterproof.



Up to 16 Million Colors

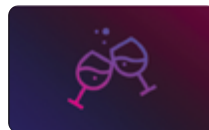

21 Recommended Scenes

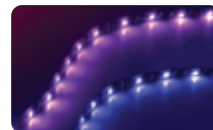

Dance with music

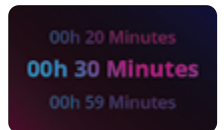

Schedule



Easy Installation



Bluetooth Control



Voice Control

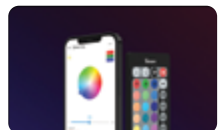

Remote Control

Download eWeLink Application.

Full info for the products, instructions can be found at [www.elmarkholding.eu](http://www.elmarkholding.eu)

**Remote-controller**  
24 buttons, press the one you want

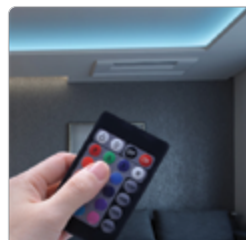

**eWeLink App**  
Schedule/Timer and more functions await for you

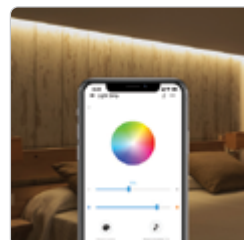

**Can be extended and controlled synchronously through the Group**

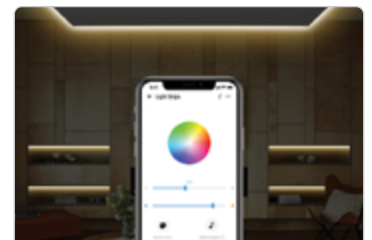

**3 YEARS TOTAL WARRANTY**  
+ 3 standard  
0 extended

**THE SET INCLUDES**

- LED Strip- 5m
- Remote Controller- 1pc
- Power AC Adapter- 1pc
- Controller- 1pc

**LED STRIP TECHNICAL DATA**

- Input voltage: 12V DC
- LED Strip Length: 5m
- LED QTY: 30 pcs/m
- Colour Temp. : RGB
- Beam angle: 140°
- Lumens: ≥300 lm/m
- Working temperature: from -10° to +50°C
- IP code: IP65

**WI-FI CONTROLLER TECHNICAL DATA**

- Input voltage: 5-12V DC
- Remote controller battery: 3V (CR2025)
- Power: 24W ( max.36W)
- Wi-Fi: IEEE 802.11 b/g/n
- Remote controller: Infrared; 24 keys

**POWER ADAPTER TECHNICAL DATA**

- Input voltage: 100-240V AC
- Output voltage: 12V
- Cable length: 1.5m
- Protections: over-voltage, overload and overheat

Catalogue number	Adapter input voltage	Controller input voltage	Colour temperature	Lumens	Packing/Box (pcs)
L2Lite-5M-EU	100-240VAC	5-12V DC	RGB	300 lm	1

Scan and watch detailed video with all product functions.

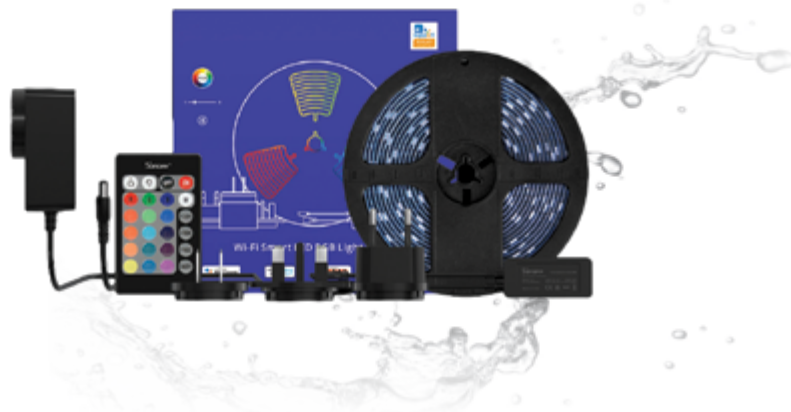

**3 YEARS TOTAL WARRANTY**  
+ 3 standard  
0 extended

DIGITAL LED STRIPS



Catalogue number: 99LED988D/IP20

The main benefit comparing to analog LED strips is that you can control every section of LEDs, separately. Traditionally, it is achieved thanks to additional chips (IC) assembled directly inside the LED diode or on the digital strip board. Each group of LEDs has an integrated circuit chip, and this integrated circuit chip controls the change of color and brightness of this group of LEDs. When switching the power, the current passed through the LEDs, causing LEDs to light up at their default settings. To create an effect, you need to enter a command on the controller.

**SMART MUSIC TUYA DIGITAL RGB + IC LED STRIP  
5M ROLL IP20, SET**

**CONTROL:** From Anywhere via Smart Device or local via remote.

**TECHNICAL DATA**

- Type: Digital RGB+IC LED strip
- Input voltage: 220-240V
- LED Driver and strip voltage: 24V DC
- Colour temperature: RGB
- LED chip: SMD 5050
- LED QTY: 30LED/m
- Beam angle: 120°
- •CRI>80
- LED strip length: 5m
- PCB board: 10mm single
- IP code of LED strip: IP20

**THE SET INCLUDES**

- 1 x LED strip 5m
- 1 x LED driver 24V/24W (1A)
- 1 x TUYA controller
- 1 x IR remote



Scan and watch detailed video with all product functions.



**Timer setting**

Schedule smart lights to accompany you fall asleep and wake up.



**3 YEARS TOTAL WARRANTY**  
+ 3 standard  
0 extended



Catalogue number: 99LED989D/IP20

### SMART MUSIC TUYA DIGITAL RGB CCT+IC LED STRIP 5M ROLL IP20, SET

#### TECHNICAL DATA

- Type: Digital RGB CCT+IC LED strip
- Input voltage: 220-240V
- LED Driver and strip voltage: 24V DC
- Colour temperature: RGB+ adjustable white colour
- White colour lumens: 68lm/W
- LED chip: SMD 2835
- LED QTY:
  - RGB: 30LED/m
  - 3000K: 30LED/m
  - 6500: 30LED/m
- Beam angle: 120°
- CRI>80
- LED strip length: 5m
- PCB board: 12mm double
- IP code of LED strip: IP20

#### THE SET INCLUDES

- 1 x LED strip 5m
- 1 x LED driver 24V/24W (1A)
- 1 x TUYA controller
- 1 x IR remote



Scan and watch detailed video with all product functions.

### SMART MUSIC TUYA DIGITAL RGB CCT+IC LED STRIP 2X5M ROLL IP20, SET

#### TECHNICAL DATA

- Type: Digital RGB CCT+IC LED strip
- Input voltage: 220-240V
- LED Driver and strip voltage: 24V DC
- Colour temperature: RGB+ adjustable white colour
- White colour lumens: 68lm/W
- LED chip: SMD 2835
- LED QTY:
  - RGB: 30LED/m
  - 3000K: 30LED/m
  - 6500: 30LED/m
- Beam angle: 120°
- CRI>80
- LED strip length: 2x5m
- PCB board: 12mm double
- IP code of LED strip: IP20

#### THE SET INCLUDES

- 2 x LED strip 5m
- 1 x LED driver 24V/36W (1.5A)
- 1 x TUYA controller
- 1 x IR remote



Scan and watch detailed video with all product functions.



Catalogue number: 99LED990D/IP20

### WATERPROOF SMART MUSIC TUYA DIGITAL RGB CCT+IC LED STRIP 2X5M ROLLS IP54, SET

#### TECHNICAL DATA

- Type: Digital RGB CCT+IC LED strip
- Input voltage: 220-240V
- LED Driver and strip voltage: 24V DC
- Colour temperature: RGB+ adjustable white colour
- White colour lumens: 68lm/W
- LED chip: SMD 2835
- LED QTY:
  - RGB: 30LED/m
  - 3000K: 30LED/m
  - 6500: 30LED/m
- Beam angle: 120°
- CRI>80
- LED strip length: 2x5m
- PCB board: 12mm double
- IP code of LED strip: IP54

#### THE SET INCLUDES

- 2 x LED strip 5m, IP54
- 1 x LED driver 24V/36W (1.5A)
- 1 x TUYA controller
- 1 x IR remote



Scan and watch detailed video with all product functions.



IP54

Catalogue number: 99LED990D/IP54

**3 YEARS TOTAL WARRANTY**  
+ 3 standard  
0 extended

## TUYA SMART DIGITAL MUSIC WALL LIGHTS 3 PCS, SET

**CONTROL:** From Anywhere via Smart Device or local via remote.

**FUNCTION**

- **Enhanced Entertainment:** These Wall connecting Ambient light gives depth of color to your home cinema in a fashionable way, making it a more spectacular entertainment system. Improve your home lighting decor for a more thrilling viewing experience
- **Light Control:** Multiple ways to change the color and modes of the Wall connecting Ambient light - App control and voice control, You can conveniently control the lights according to your needs.
- **Wall installation:** Install directly on the wall to add color to a monotonous wall. Different lighting modes can be applied to different scenes to create a variety of atmosphere, which is a perfect decoration for festivals and gatherings.

**TECHNICAL DATA**

- Type: TUYA smart light RGB+IC
- Input voltage: 220-240V
- LED Driver and strip voltage: 12V DC
- Colour temperature: RGB
- Power: 3x3.5W
- LED QTY: 30LED/pcs
- Beam angle: 180°
- Material: ABS+PC
- Dimension (DxH): 400x30mm

**THE SET INCLUDES**

- 3 x Wall lamp
- 1 x power supply
- 1 x TUYA controller



Catalogue number: 99LED991/3W



Scan and watch detailed video with all product functions.

**Light control is getting easier**

Multiple ways to change the color and modes.

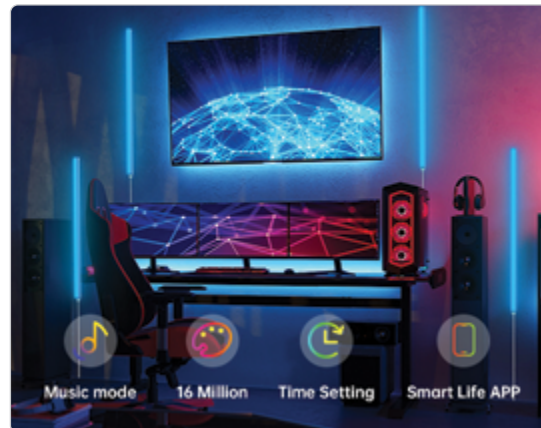
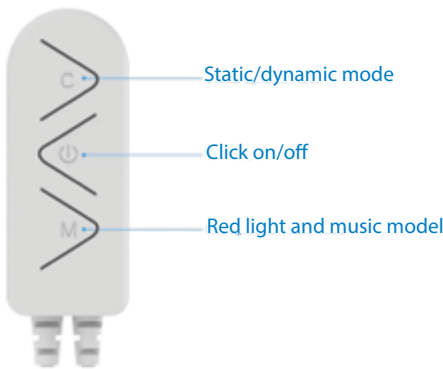

**Easy wall installation**

Install directly on the wall to add color to a monotonous wall.



**3 YEARS TOTAL WARRANTY**  
+ 3 standard  
0 extended

## TUYA SMART DIGITAL MUSIC WALL LIGHTS 6 PCS, SET

**CONTROL:** From Anywhere via Smart Device or local via remote.

### FUNCTION

- **Enhanced Entertainment:** These Wall connecting Ambient light gives depth of color to your home cinema in a fashionable way, making it a more spectacular entertainment system. Improve your home lighting decor for a more thrilling viewing experience
- **Light Control:** Multiple ways to change the color and modes of the Wall connecting Ambient light - App control and voice control, You can conveniently control the lights according to your needs.
- **Wall installation:** Install directly on the wall to add color to a monotonous wall. Different lighting modes can be applied to different scenes to create a variety of atmosphere, which is a perfect decoration for festivals and gatherings.

### TECHNICAL DATA

- Type: TUYA smart light RGB+IC
- Input voltage: 220-240V
- LED Driver and strip voltage: 12V DC
- Colour temperature: RGB
- Power: 6x3.5W
- LED QTY: 30LED/pcs
- Beam angle: 180°
- Material: ABS+PC
- Dimension (DxH): 400x30mm

### THE SET INCLUDES

- 6 x Wall lamp
- 1 x power supply
- 1 x TUYA controller



Scan and watch detailed video with all product functions.



Catalogue number: 99LED991/6W

### Light control is getting easier

Multiple ways to change the color and modes.

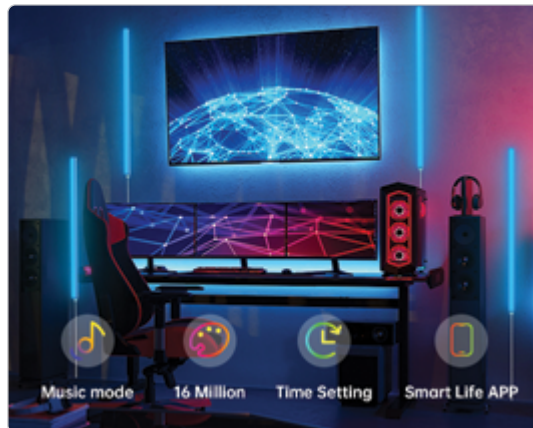
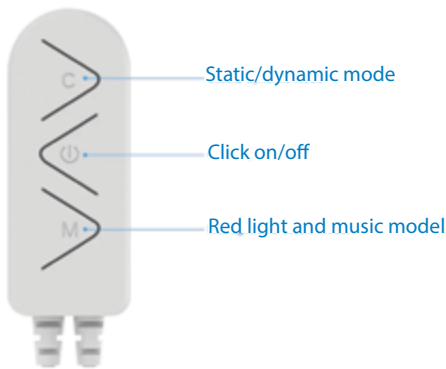

### Easy wall installation

Install directly on the wall to add color to a monotonous wall.

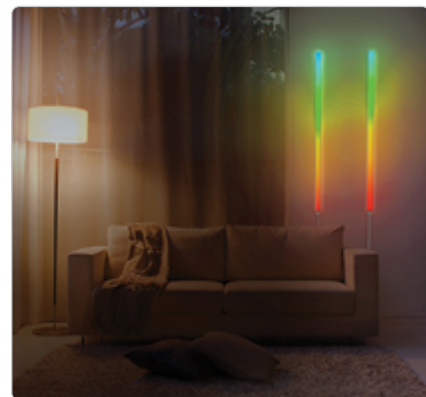

**3 YEARS TOTAL WARRANTY**  
+ 3 standard  
0 extended

## TUYA SMART MUSIC DIGITAL CORNER LAMP RGB+ CCT, SET

**CONTROL:** From Anywhere via Smart Device or local via remote.

### FUNCTION

- Light Control: Adjust the brightness, color, effect and speed parameters as needed
- Easy to Install: the smart floor Light is composed of a silicone lampshade, color LED lamp beads, aluminum strip, and detachable solid tripod.

### TECHNICAL DATA

- Type: TUYA smart light RGB+CCT+IC
- Input voltage: 220-240V
- LED Driver and strip voltage: 12V DC
- Colour temperature: RGB+ CCT (3000K & 6500K) adjustable
- LED Chip: SMD5050 + SMD2835
- LED QTY: 60 RGB LEDs + 60 LEDs 3000K & 6500K
- Lamp length: 1400mm
- Holder length: 400mm

### THE SET INCLUDES

- 1 x Corner lamp with holder
- 1 x LED driver 12V/1A
- 1 x TUYA Bluetooth controller
- 1 x 26 key IR remote



Scan and watch detailed video with all product functions.



Catalogue number: 99LED992/RGB+CCT

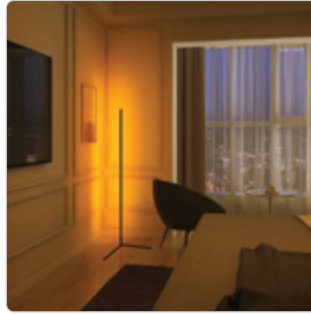

**3 YEARS TOTAL WARRANTY**  
+ 3 standard  
0 extended

## TUYA SMART MUSIC DIGITAL CORNER LAMP CCT, SET

**CONTROL:** From Anywhere via Smart Device or local via remote.

### FUNCTION

- Light Control: Adjust the brightness, color, effect and speed parameters as needed
- Easy to Install: the smart floor Light is composed of a silicone lampshade, color LED lamp beads, aluminum strip, and detachable solid tripod.

### TECHNICAL DATA

- Type: TUYA smart light CCT+IC
- Input voltage: 220-240V
- LED Driver and strip voltage: 12V DC
- Colour temperature: CCT (3000K & 6500K) adjustable
- LED Chip: SMD2835
- LED QTY: 120pcs
- Lamp length: 1400mm
- Holder length: 400mm

### THE SET INCLUDES

- 1 x Corner lamp with holder
- 1 x LED driver 12V/1A
- 1 x TUYA Bluetooth controller
- 1 x 24 key IR remote



Scan and watch detailed video with all product functions.



Catalogue number: 99LED992/CCT

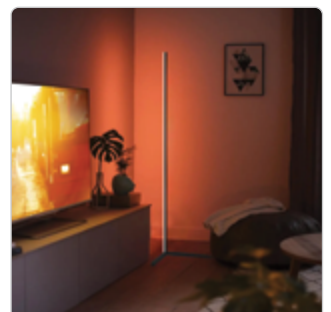
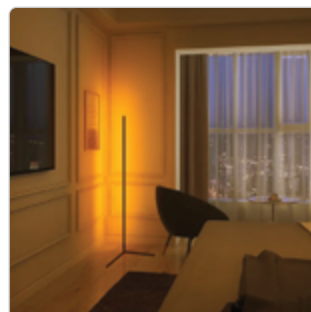



## BLUETOOTH MUSIC DIGITAL DESKTOP LAMPS RGB+W, SET

**CONTROL:** Via bluetooth or remote device.

### FUNCTION

- Micro USB interface: The smart atmosphere light supports multiple equipment power supply, and can be powered anywhere with a USB port, which is very convenient
- Multi-scene Mode: There are four scenes: classic, soft, dynamic, disco.
- Light Control: Two ways to change the color and modes - App control and physical button control, you can conveniently control the lights according to your need
- Music Mode: The color of the light will change with the music, allowing you to experience more interesting scenes, and let the music make life more rhythmic.

### TECHNICAL DATA

- Type: Digital bluetooth lights RGBW+IC
- Input voltage: 220-240V
- Output voltage: 5V DC
- Colour temperature: RGB+ W (4000K)
- Power: 2x2.5W
- LED QTY: 15 RGB LEDs + 15 LEDs 4000K
- Material: ABS+PC
- Dimensions (DxH): 300x30mm

### THE SET INCLUDES

- 2 x Desktop lamps
- 1 x USB cable 1m
- 1 x remote control

Scan and watch detailed video with all product functions.

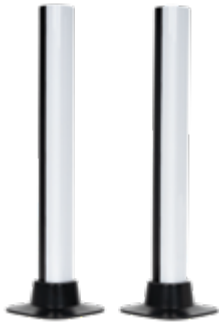

Catalogue number: 99LED993/RGBW



### Add color to your desktop

Different lighting modes can be applied to different scenes to create a variety of atmosphere.



## WI-FI MUSIC DIGITAL DESKTOP LAMPS RGB, SET

**CONTROL:** From Anywhere via Smart Device or local via remote.

### FUNCTION

- Micro USB interface: The smart atmosphere light supports multiple equipment power supply, and can be powered anywhere with a USB port, which is very convenient
- Multi-scene Mode: There are four scenes: classic, soft, dynamic, disco.
- Light Control: Two ways to change the color and modes - App control and physical button control, you can conveniently control the lights according to your need
- Music Mode: The color of the light will change with the music, allowing you to experience more interesting scenes, and let the music make life more rhythmic.

### TECHNICAL DATA

- Type: Digital bluetooth lights RGBW+IC
- Input voltage: 220-240V
- Output voltage: 5V DC
- Colour temperature: RGB
- Power: 2x4W
- LED QTY: 30 pcs
- Material: ALU+PC
- Dimensions (DxH): 550x30mm

### THE SET INCLUDES

- 2 x Desktop lamps
- 1 x USB cable 1m
- 1 x remote control

Scan and watch detailed video with all product functions.

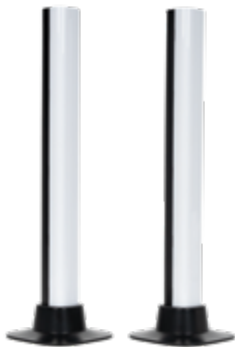

Catalogue number: 99LED994/RGB



### Add color to your desktop

Different lighting modes can be applied to different scenes to create a variety of atmosphere.



**3 YEARS TOTAL WARRANTY**  
+ 3 standard  
0 extended

BLUETOOTH SMART LED STRIPS

**BLUETOOTH SMART RGB LED STRIP LIGHT WITH MUSIC/SOUND CONTROL, SET**



**CONTROL:** With Smart Device via Bluetooth or by Remote.

**FUNCTION**

- DIY mode: 16 million colours, adjustable speed and brightness let your creativity run wild. Create your own dynamic interior lighting effects in the Lotus Lantern app and also share them with the community.
- Static colour: 8
- Microphone: Built-in high sensitivity microphone. The colours will sync with music or any sound captured by mic
- ON/OFF On Schedule: Free your hands, set your daily routine.
- Music modes: 4
- Music sensitivity: Adjustable
- Brightness: Adjustable.

**TECHNICAL DATA**

- Input voltage: 5-24V DC
- LED Strip Length: 4x220mm
- LED QTY: 4x12pcs
- Colour: Multicolour

**THE SET INCLUDES**

- USB connector
- Car Charger
- 20 keys remote control
- Bluetooth controller
- 4 strip lights with 12 LED,s and length 220mm

*Download Lotus Lantern APP. Full info for the products, instructions can be found at [www.elmarkholding.eu](http://www.elmarkholding.eu)*



Remote Control



Music Sync



Bluetooth Control



Scene Scene



Scan and watch detailed video with all product functions.

Catalogue number	Input voltage	Output current	Packing/Box (pcs)
99LED985S	5-24V DC	5A	1

**3 YEARS TOTAL WARRANTY**  
+ 3 standard  
0 extended

**BLUETOOTH SMART LED STRIP LIGHT WITH MUSIC/SOUND CONTROL, SET**

**CONTROL:** With Smart Device via Bluetooth or by Remote.

**FUNCTION**

- DIY mode: adjustable speed and brightness let your creativity run wild. Create your own dynamic interior lighting effects in the Lotus Lantern app and also share them with the community.
- Static colour: 8
- Microphone: Built-in high sensitivity microphone. The colours will sync with music or any sound captured by mic
- ON/OFF On Schedule: Free your hands, set your daily routine.
- Music modes: 4
- Music sensitivity: Adjustable
- Brightness: Adjustable.

**TECHNICAL DATA**

- Input voltage: 100-240V AC 50/60Hz
- LED Strip Length: 2x5m
- LED QTY: 60pcs/m
- Colour: Multicolour
- IP65

**THE SET INCLUDES**

- 2 rolls-10 meters with 300LEDs strip
- 40 keys remote control
- Adapter 100-240V to 12V/6A
- Bluetooth controller

*Download Lotus Lantern APP. Full info for the products, instructions can be found at [www.elmarkholding.eu](http://www.elmarkholding.eu)*



Scan and watch detailed video with all product functions.



Remote Control



Music Sync



Bluetooth Control



Scene Scene

Catalogue number	Input voltage	Output current	Ingress Protection	Packing/Box (pcs)
99LED987S	100-240V AC	12V/ 6A	IP65	1

## BLUETOOTH 5V TV LED STRIP, SET

**CONTROL:** With Smart Device via Bluetooth or by Remote.

### FUNCTION

- Control: via remote
- DIY mode: adjustable speed and brightness  
let your creativity run wild.
- Static colour: 8
- Brightness: Adjustable



Scan and watch detailed video with all product functions.



Remote Control



Bluetooth Control



Scene Scene

Download Lotus Lantern APP. Full info for the products, instructions can be found at [www.elmarkholding.eu](http://www.elmarkholding.eu)

### TECHNICAL DATA

- Input voltage: 5V
- LED Strip Length: 3m
- Colour: Multicolour

### THE SET INCLUDES

- 3 meters USB Bluetooth TV strip with 90LEDS
- 24 keys remote control
- USB cable
- Bluetooth controller

Catalogue number	Input voltage	Output current	Packing/Box (pcs)
99LED986S	5V	5A	1



**3 YEARS TOTAL WARRANTY**  
+ 3 standard  
0 extended

## REMOTE CONTROL SWITCHES

### Cable-less connection

The remote devices for lighting control work through sending a frequent signal from the key to the receiver, which commands the connected to it lighting bodies. The installation of the key can be done in a standard round bracket as the advantage of this product is that there is no additional requirement for wiring from it towards the receiver. Thanks to this the product is widely used in premises with build in installations where there is no ability for adding the additional cable layouts and expenses for their building are reserved. The connection between the key and the receiver is through a frequent signal in the range -315Mhz – 433.92 Mhz.



### ONE WAY REMOTE CONTROL SWITCH SURFACE MOUNTING

Catalogue number	Description	Battery	Operating distance in open air (m)	Output power (per way) ESL/ LED lamp	Incandescent lamp	Packing/ Box (pcs)
99101	One way output power	12V 23A	50	200W	600W	1/60



### TWO WAYS REMOTE CONTROL SWITCH SURFACE MOUNTING

Catalogue number	Description	Battery	Operating distance in open air (m)	Output power (per way) ESL/ LED lamp	Incandescent lamp	Packing/ Box (pcs)
99102	Two ways output power	12V 23A	50	200W	600W	1/60



### THREE WAYS REMOTE CONTROL SWITCH SURFACE MOUNTING

Catalogue number	Description	Battery	Operating distance in open air (m)	Output power (per way) ESL/ LED lamp	Incandescent lamp	Packing/ Box (pcs)
99103	Three ways output power	12V 23A	50	200W	600W	1/60



### TWO WAYS REMOTE CONTROL SWITCH WITH LED LAMPS SURFACE MOUNTING

Catalogue number	Description	Battery	Operating distance in open air (m)	Output power (per way) ESL/ LED lamp	Incandescent lamp	Packing/ Box (pcs)
99104	Three ways output power - 2xE27	12V 23A	50	150W	400W	1/60



**2 YEARS TOTAL WARRANTY**  
+ 2 standard  
0 extended

# SMART & SECURITY CAMERAS



SMART CAMERAS



Catalogue number: S-CAM

**INDOOR WIRELESS SMART CAMERA**

CAM Slim smart home security camera offers 1080P HD resolution, night vision, motion detection & alarm to keep your home in a secure environment, day and night. Start recording as an executive action, CAM Slim starts recording as soon as the door opens to supervise your bedroom with eWeLink Camera Plan(subscription sold separately). RTSP protocol allows you to view the monitoring screen on your PC with eWeLink Camera Plan(subscription sold separately). Two-way audio always lets you communicate with pets, and family anywhere, anytime. CAM Slim supports max. 256G Micro SD card storage and mass cloud storage. Flexible and Easy Design provides you with many installation method choices, like magnetic mount, stick, and screw mount, you can also mount on tripods that screw 1/4 inch.

**CONTROL:** From Anywhere via Smart Device.

**FUNCTION**

- Trigger Event Recording by Sensor: The sensor device triggers the recording of CAM Slim, such as SNZB-03 motion sensor, starts recording when detected the motion.
- Motion Detection & Alarm: Alarm in your setting effective period, avoid frequent alarms in the low peak periods.
- RTSP Settings: RTSP protocol allows you to view the monitoring screen on your PC.
- Two-way Audio: Respond to your family, and visitors anytime, anywhere.
- Scene Linkage with SONOFF Device: Scene Linkage with DUALR3 smart switch, alarm when the garage door opens to scare away thieves.
- Local & Cloud Storage: You can choose to save and share video with a free 30-day trial cloud storage of the Camera Plan or locally saved with SD card (sold separately).

**HD**

1080P HD Images



Two-way Audio



IR Night Vision



Motion Detection



Activity Alert



360° Viewing Angle

**RTSP**

RTSP Protocol

**TF**

TF Card Supported

Download IPC360 Application.

Full info for the products, instructions, can be found at [www.elmarkholding.eu](http://www.elmarkholding.eu)

**TECHNICAL DATA**

- Input: 5V/1A Type C
- Resolution: 1080P
- Lens Aperture: F2.3
- Material: ABS
- Video Compression Standard: H.264
- Wi-Fi: IEEE 802.11 b/g/n 2.4GHz
- Work temperature: from -10 to 40°C
- Viewing Angle: 130°
- Storage: TF card (Max. 256G) not included.
- Dimension (LxH): 53x91 mm

Note: Wi-Fi IP security camera come without adapter. Power input Type C

Scan and watch detailed video with all product functions.



**View monitoring screen on PC**

RTSP protocol allows you to view the monitoring screen on your PC



**3 YEARS TOTAL WARRANTY**  
+ 3 standard  
0 extended



Catalogue number: GK-200MP2-B

## INDOOR WIRELESS IP SECURITY CAMERA

Wireless IP Security Camera offers outstanding full HD 1080P resolution and 340° wide monitoring angles to keep your home in a secure environment, day or night. Features IR night vision, motion detection and instant motion alert and two-way audio which always gets you to know what's going on in your home anywhere, anytime. Supports max. 128G TF card to store your more precious memory. Plus, Wi-Fi and Ethernet network connection are available.

**CONTROL:** From Anywhere via Smart Device.

### FUNCTION

- **Patrolling Without Blind Spot:** Complete 340° coverage ensures each corner is visible.
- **Two-Way Audio:** View and communicate with your family anytime, anywhere.
- **Motion Detection Alerts:** An alarm notification will be pushed to your phone once someone is detected.
- **Compatible With NVR Devices:** Enable RTSP protocol on App to connect your NVR devices and the camera.
- **Trigger Event Recording by Sensor:** With eWeLink Camera Plan(subscription sold separately), the sensor device triggers the recording of camera, such as DW2-WiFi door/window sensor, starts recording when detected the motion
- **Local & Cloud Storage:** You can choose to save and share video with a free 30-day trial cloud storage of the Camera Plan or locally saved with SD card (sold separately).

**HD**

1080P HD Images



Two-way Audio



IR Night Vision



Motion Detection



Activity Alert



360° Viewing Angle

**RTSP**

RTSP Protocol

**TF**

TF Card Supported

Download eWeLink Application.

Full info for the products, instructions can be found at [www.elmarkholding.eu](http://www.elmarkholding.eu)

### TECHNICAL DATA

- Input: 5V/1A
- Resolution: 1080P
- Lens Aperture: F1.2
- Material: ABS
- Video Compression Standard: H.264
- Wi-Fi: IEEE 802.11 b/g/n 2.4GHz
- Work temperature: from 0 to 55°C
- Viewing Angle: 340° horizontal / 120° vertical
- Storage: TF card (Max. 128G) not included.
- Dimension (LxWxH): 109x109x120 mm

Scan and watch detailed video with all product functions.



### ADAPTERS FOR GK-200MP2-B:



EU Standard  
Cat. number: TPF-DE



UK Standard  
Cat. number: TPG-UK

\* The adapters are not included, please purchase them separately.

### Monitoring without blind spot

Complete 360° coverage ensures every corner is visible



340° Pan

120° Tilt

### Even see clearly at night

IR night vision. Infrared LEDs are automatically activated in low-light

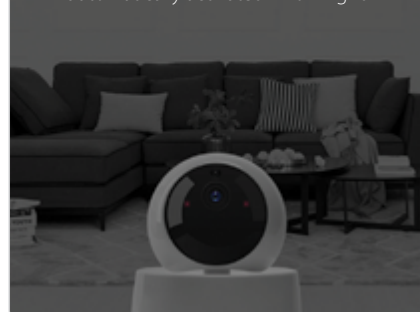



Catalogue number: 195045



## INDOOR TUYA SMART WI-FI CAMERA, EL-Q05C

**CONTROL:** From Anywhere via Smart Device.

### FUNCTION

- Control is done from anywhere with IOS or Android mobile application
  - Human and motion detection: with AI humanoid detection function, can reduce false alarms caused by leaves, insects or other object
  - Smart sound detection: When sound is detected by the camera, the notification will be sent immediately through the APP. Baby crying sound detection
  - Full color night vision, day and night mode automatic switching, support IR distance of 10 meters
  - Real time email alert: If the camera detects humanoid movements, camera will send you an alarm message notification. You can know that someone is approaching your home anytime, anywhere
  - Pan-tilt control: The camera can provide 90° vertical and 355° horizontal rotation range.
- Controlling the camera via TUYA APP.
- Support micro SD card max 128 GB and 7 days free cloud storage.
  - Two-Way Audio, allows you to listen and speak through the camera.
  - P2P remote access and multi-user, you can view the real-time situation of your home view the real-time situation of your home anytime and anywhere with your smartphone or tablet.
  - Multiple installation methods: Place it on wall or on the ceiling.

### TECHNICAL DATA

- Input voltage: DC5V/1A. Can be powered with USB cable
- IR Range: Up to 10 meters
- Resolution: 1920x1080 (2MP)
- Lens aperture: F2.0
- Battery type: 18650 rechargeable
- Wi-Fi: IEEE 802.11 b/g/n 2.4GHz

Download TUYA Smart Application.

Full info for the products, instructions, can be found at [www.elmarkholding.eu](http://www.elmarkholding.eu)

**3 YEARS TOTAL WARRANTY**  
+ 3 standard  
0 extended

### What's in the box?

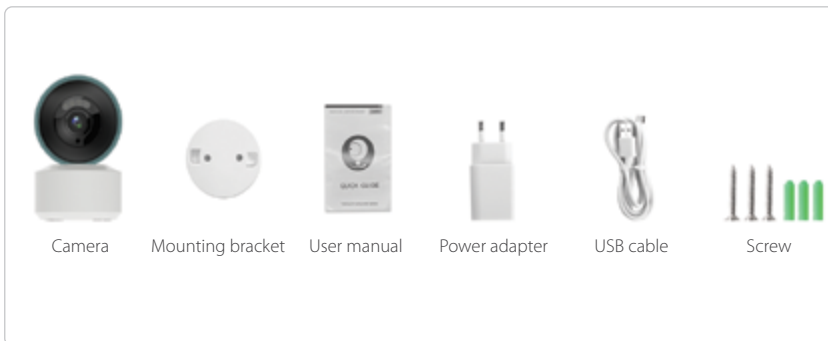

### SD Card & Cloud Storage

Supports micro SD cards with up to 128Gb storage capacity and 7 days free cloud storage.



### Full colour night vision

Automatically adjust the intensity of the infrared LED's, get more details captured within 10 meters.



### Pan-Tilt Control

The camera can provide 90° vertical and 355° horizontal rotation range. Controlling the camera via the TUYA APP.



### Two-Way Audio Intercom

Keep in touch with your home through the Mic and speaker.





**3 YEARS TOTAL WARRANTY**  
+ 3 standard 0 extended



Catalogue number: 195046



## INDOOR TUYA SMART WI-FI CAMERA, EL-Q502B

**CONTROL:** From Anywhere via Smart Device.

### FUNCTION

- Control is done from anywhere with IOS or Android mobile application
- Human and motion detection: with AI humanoid detection function, can reduce false alarms caused by leaves, insects or other object
- Smart sound detection: When sound is detected by the camera, the notification will be sent immediately through the APP. Baby crying sound detection
- Full color night vision, day and night mode automatic switching, support IR distance of 10 meters
- Real time email alert: If the camera detects humanoid movements, the camera will send you an alarm message notification. You can know that someone is approaching your home anytime, anywhere
- Pan-tilt control: The camera can provide 90° vertical and 355° horizontal rotation range. Controlling the camera via TUYA APP.
- Support micro SD card max 128 GB and 7 days free cloud storage.
- Two-Way Audio, allows you to listen and speak through the camera.
- P2P remote access and multi-user, you can view the real-time situation of your home view the real-time situation of your home anytime and anywhere with your smartphone or tablet.
- Multiple installation methods: Place it on wall or on the ceiling

### TECHNICAL DATA

- Input voltage: DC5V/1A. Can be powered with USB cable
- IR Range: Up to 10 meters
- Resolution: 1920x1080 (2MP)
- Lens aperture: F2.0
- Battery type: 18650 rechargeable
- Wi-Fi: IEEE 802.11 b/g/n 2.4GHz

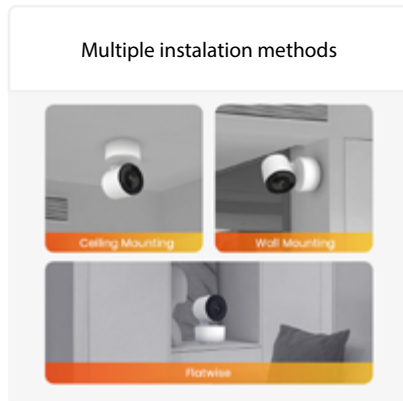
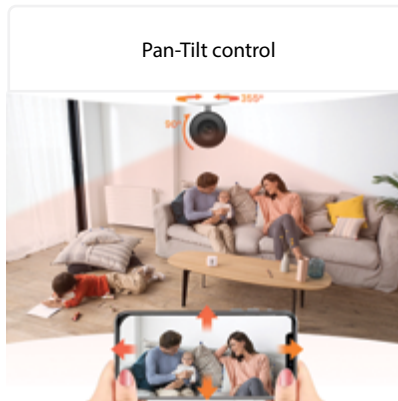
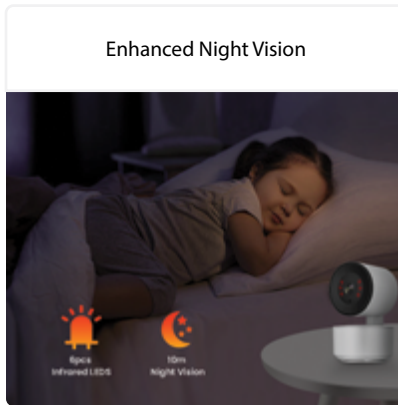



Catalogue number: 195052



## INDOOR WIRELESS SMART CAMERA

**CONTROL:** From Anywhere via Smart Device.

### FUNCTION

- Control is done from anywhere with IOS or Android mobil application
- Different view settings
- Support TF recording & Cloud storage
- Two-way voice communication
- Motion detection voice alarm & save alarm video
- Detailed alarm sector setting
- Sending images
- Night vision

### TECHNICAL DATA

- Input voltage: 100-240VAC
- Output voltage: 5V
- Cover range: 50m
- View angle: 360°
- Effective pixel: HD 1080P



Remote Control

**HD**

1080P HD Images



Two-way Audio



IR Night Vision



Motion Detection



Activity Alert

Download IPC360.Application.

Full info for the products, instructions, can be found at [www.elmarkholding.eu](http://www.elmarkholding.eu)



Catalogue number: 195067



## WIRELESS SMART CAMERA

**CONTROL:** From Anywhere via Smart Device.

### FUNCTION

- Control is done from anywhere with IOS or Android mobile application
- Support TF recording & Cloud storage
- Two-way voice communication
- Motion detection alarm
- Detailed alarm sector setting
- Sending images
- Night vision

### TECHNICAL DATA

- Input voltage: 100-240VAC
- Output voltage: 5V, 1A
- Speaker: 8Ω 1W
- Field of view: H:86° (355°)/V:64°(90°)
- Resolution: 1280×720(1.0MP)
- Wireless Frequency: 2.4GHz~2.4835 GHz



Remote Control

**HD**

1080P HD Images



Two-way Audio



IR Night Vision



Motion Detection



Activity Alert

### Even see clearly at night

Night vision mode



### Two-way audio

See, listen and talk, anytime, anywhere

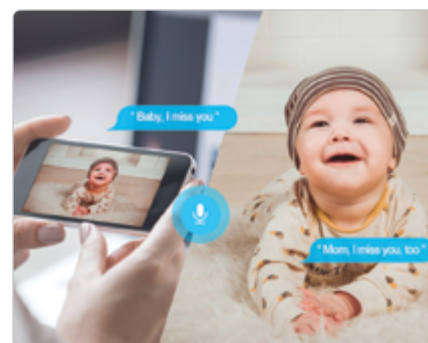

**3 YEARS TOTAL WARRANTY**  
+ 3 standard  
0 extended



Catalogue number: 195068



## INDOOR WIRELESS SMART CAMERA

**CONTROL:** From Anywhere via Smart Device.

### FUNCTION

- Control is done from anywhere with IOS or Android mobile application
- Support TF recording & Cloud storage
- Two-way voice communication
- Motion detection alarm
- High quality videos
- Night vision
- Sending images

Download IPC360 Application.

Full info for the products, instructions, can be found at [www.elmarkholding.eu](http://www.elmarkholding.eu)

### TECHNICAL DATA

- Input voltage: 100-240VAC
- Output voltage: 5V, 2A
- Speaker: 8Ω 1W
- Field of view: H:86° (355°)/V:64°(90°)
- Resolution: 1920×1080(2.0MP)
- Wireless Frequency: 2.4GHz~2.4835 GHz



Remote Control

**HD**

1080P HD Images



Two-way Audio



IR Night Vision



Motion Detection



Activity Alert

### Even see clearly at night

Night vision mode



### Two-way audio

See, listen and talk, anytime, anywhere

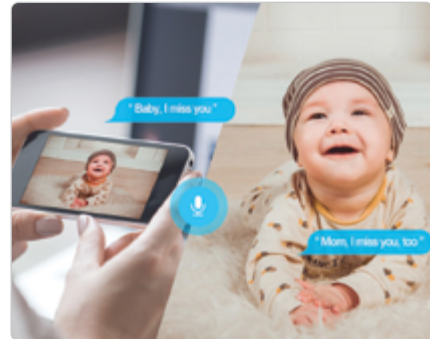

**3 YEARS TOTAL WARRANTY**  
+ 3 standard  
0 extended



Catalogue number: 195049

Scan and watch detailed video with all product functions.



## OUTDOOR TUYA SMART WI-FI CAMERA IP66

**CONTROL:** From Anywhere via Smart Device.

### FUNCTION

- Control is done from anywhere with IOS or Android mobile application
- Automatic tracking and sound alarm. When somebody move, the WI-FI camera automatically track the body
- Support Email alarm, app alarm push and alarm snapshot
- Full color night vision, day and night mode automatic switching, support IR distance of 15 meters
- Convenient remote PTZ control. This camera can rotate 355 degrees horizontally and rotate 90 degrees vertically
- Support SD card max 128 GB and cloud recording, data security is more stable
- Two-Way Audio, allows you to listen and speak through the camera.
- P2P remote access and multi-user, you can view the real-time situation of your home anytime and anywhere with your smartphone or tablet.

### TECHNICAL DATA

- Input voltage: 100-240VAC
- Output voltage: 12V DC/ 2A
- HD 1080P Resolution
- 4 IR & 4 White LED Distance up to 15m
- Resolution: 1920x1080 (2MP)
- Focal length: 3.6mm, 85° view angle
- Pan/Tilt: Pan: 355°, Tilt: 90°
- Compression: H.264
- SD card storage: up to 128G
- Night vision distance: 15m
- Wi-Fi: IEEE 802.11 b/g/n 2.4GHz
- IP code: IP66

Download TUYA Smart Application.

Full info for the products, instructions, can be found at [www.elmarkholding.eu](http://www.elmarkholding.eu)



### Human & Motion Detection



### Full Color Night Vision



The camera can provide 90°vertical and 355°horizontal rotation range



### IP66 Waterproof

It can resist rainy, sunny and snowy weather.



**3 YEARS TOTAL WARRANTY**  
+ 3 standard  
0 extended

## OUTDOOR TUYA SMART WI-FI SOLAR CAMERA IP66

**CONTROL:** From Anywhere via Smart Device.

### FUNCTION

- Control is done from anywhere with IOS or Android mobile application
- With PIR motion sensor, PIR human body detection wake up camera
- Built-in rechargeable lithium battery with long battery life functions for up to 6 months
- Compatible with Android and IOS smart terminals to support remote real-time monitoring
- Support cloud storage, Micro SD card (up to 128GB) and mobile video recording
- Full color night vision, 10m night vision distance, 24 hours all day monitoring
- Two-Way Audio, allows you to listen and speak through the camera.
- P2P remote access and multi-user, you can view the real-time situation of your home anytime and anywhere with your smartphone or tablet.

### TECHNICAL DATA

- Input voltage: DC5V/2A. Can be powered by solar panel or with USB cable
- HD 2K Resolution
- IR Range: Up to 10 meters
- Resolution: 1920x1080 (2MP)
- Focal length: 2.8mm
- Angle of view: 120°
- Compression: H.264
- Battery capacity: 2x2600mAh
- Battery type: 18650 rechargeable
- Standby Consumption: 0.5mA
- Work Consumption: 200mA
- SD card storage: up to 128G
- Night vision distance: 10m
- Wi-Fi: IEEE 802.11 b/g/n 2.4GHz
- IP code: IP66
- Material: ABS

Download TUYA Smart Application.  
Full info for the products, instructions, can be found at [www.elmarkholding.eu](http://www.elmarkholding.eu)



Li-ion

Catalogue number: 195047

Scan and watch detailed video with all product functions.



### 3MP Solar Battery Camera

365 Day protect your home.



### 100% Wireless Non-Stop Power

Powered by a solar panel or a USB cable.



**3 YEARS TOTAL WARRANTY**  
+ 3 standard 0 extended

### PIR Motion Detection



### Full Color Night Vision

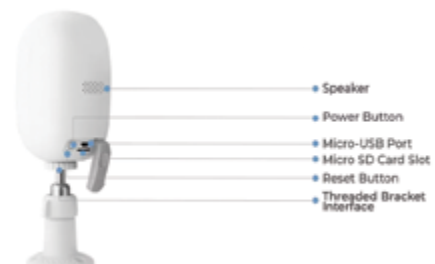



Li-ion

Catalogue number: 195048

Scan and watch detailed video with all product functions.



## OUTDOOR TUYA SMART WI-FI CAMERA WITH BUILT-IN BATTERY, IP66

**CONTROL:** From Anywhere via Smart Device.

### FUNCTION

- Control is done from anywhere with IOS or Android mobile application
- With PIR motion sensor, PIR human body detection wake up camera
- Built-in rechargeable lithium battery with long battery life functions for up to 6 months
- Compatible with Android and IOS smart terminals to support remote real-time monitoring
- Support cloud storage, Micro SD card (up to 128GB) and mobile video recording
- Full color night vision, 15m night vision distance
- Two-Way Audio, allows you to listen and speak through the camera.
- P2P remote access and multi-user, you can view the real-time situation of your home anytime and anywhere with your smartphone or tablet.

Download TUYA Smart Application.  
Full info for the products, instructions, can be found at [www.elmarkholding.eu](http://www.elmarkholding.eu)

### TECHNICAL DATA

- Input voltage: DC5V/2A. Can be powered with USB cable
- IR Range: Up to 15 meters
- Resolution: 1920x1080 (2MP)
- Sensor: 2.0MP 1/2.9" CMOS Sensor
- Focal length: 3.6mm
- Illumination: Minimum illumination black and white: 0.01 Lux
- Angle of view: 130°
- Compression: H.264
- Battery capacity: 2x2600mAh
- Battery type: 18650 rechargeable
- PIR motion distance: 3-8m
- SD card storage: up to 128G
- Night vision distance: 10m
- Wi-Fi: IEEE 802.11 b/g/n 2.4GHz
- IP code: IP66
- Material: ABS
- PIR motion distance: 3-8m
- SD card storage: up to 128G
- Night vision distance: 10m
- Wi-Fi: IEEE 802.11 b/g/n 2.4GHz
- IP code: IP66
- Material: ABS

### 12 Core Functions

Low-Power Battery Camera



### IP66 Dustproof & Waterproof

It can resist rainy, sunny and snowy weather.

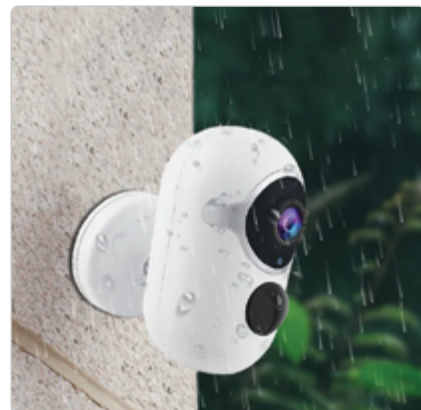

**3 YEARS TOTAL WARRANTY**  
+ 3 standard  
0 extended



Catalogue number: 195054

### HD 2MP BULLET CAMERA IP66

#### CAMERA TECHNICAL DATA

- IR Distance: up to 20m
- Image Sensor: 1/2.9" progressive CMOS
- Signal system: PAL/NTSC
- Frame Rate: AHD/TVI/CVI: P/25fps N/30fps/ CVBS: 960H
- Resolution: 2MP 1920(H)×1080(V)
- Lens: 3.6mm
- Day & Night: IR cut filter: 850nm
- Synchronization: internal
- Dwdr: support
- Communication: Up the coax, protocol



#### MENU

- AGC: yes
- Day/Night Mode: EXT/auto/color/black and white)
- White balance: auto/manual
- BLC: yes
- S/N ratio: 40dB
- OSD: support

#### INTERFACE

- Video Output: 1-channel BNC video output
- Switch Button: AHD/TVI/CVI/CVBS



Catalogue number: 195055

### HD 2MP DOME CAMERA IP66

#### CAMERA TECHNICAL DATA

- IR Distance: up to 15m
- Image Sensor: 1/2.9" progressive CMOS
- Signal system: PAL/NTSC
- Frame Rate: AHD/TVI/CVI: P/25fps N/30fps/ CVBS: 960H
- Resolution: 2MP 1920(H)×1080(V)
- Lens: 3.6mm
- Day & Night: IR cut filter: 850nm
- Synchronization: internal
- Dwdr: support
- Communication: Up the coax, protocol



#### MENU

- AGC: yes
- Day/Night Mode: EXT/auto/color/black and white)
- White balance: auto/manual
- BLC: yes
- S/N ratio: 40dB
- OSD: support

#### INTERFACE

- Video Output: 1-channel BNC video output
- Switch Button: AHD/TVI/CVI/CVBS



Catalogue number: 195069

### 4 CHANNEL WI-FI NETWORK VIDEO RECORDERS+4 CAMERA, SET

**CONTROL:** From Anywhere via Smart Device.

#### NVR TECHNICAL DATA

- Compression format: H.265+
- Operation system: Linux- embedded
- Video-input: 4\*1080P
- Audio compression: G.711A
- Display resolution: Max 1080P
- Record resolution: Analog : 1080P
- Access bandwidth: 24Mbps
- Forwarding bandwidth: 24Mbps
- Maximum decode performance: 4x1080P
- Recording mode: Manual>Alarm>Dynamic Detection>Timing
- Network interface: 1\*RJ45 10M/100M Adaptive Ethernet port+4ch WIFI
- HDD interface: 1SATA, up to 8TB for each disk- not included



#### CAMERA TECHNICAL DATA

- IR Distance: 20-30m
- Sensor: progressive scan
- Low illumination: Color: 0.1 Lux; B/W: 0.01 Lux
- Effective pixel: HD 1080P
- Video compression: H.265+
- Lens: HD 3.6mm
- Day & Night: IR cut filter with auto switch
- Power supply: DC12V 1A
- Consumption: max 6W
- IP66



Remote Control



Share control



LAN Control

**3 YEARS TOTAL WARRANTY**  
+ 3 standard 0 extended





Catalogue number: 195060

## 4 CHANNEL DIGITAL VIDEO RECORDERS

### TECHNICAL DATA

- Channels: 4
- Compression format: H.265
- Video system: NTSC/PAL
- Operation system: Linux- embedded
- Analog video-input /output: 4CH inputs / VGA and HDMI output
- IP Video Input: 2ch (only IP up to 6ch)
- Composite video input: up to 6ch (Analog video + IP video)
- Audio input /output: 1CH input /1CH output(RCA)
- Display resolution: Analog :1080N/720P/960H, IP:1080P/720P
- Display feature: single/Quad/S.E.Q.
- Record resolution: Analog :1080N/720P/960H, IP:1080P/720P
- Maximum input bandwidth: 8Mbps~16Mbps (default is 8Mbps, decrease one Analog channel can increase 4Mbps)
- Maximum output bandwidth: 16Mbps
- Maximum decode performance: 1080N:140fps
- Recording mode: Continuous/Manual/ Motion detect
- Network type: Lan, DHCP, and DDNS
- HDD interface: 1SATA HDD, up to 6TB
- Multiplex operation: live display, record, playback, backup and network
- USB: 2xUSB(for mouse and backup/upgrade)
- PTZ control: yes (RS485)
- Mobile surveillance: Support Mobile Phones based on iPhone and Android operation system
- VGA/HDMI: 1024\*768,1280\*1024,1440\*900, 1920\*1080
- Power supply: DC 12V/2A
- Dimension(WxDxH): 300x227x53mm
- Working temperature: -10°C~+55°C
- Working humidity: 10%~90%



Catalogue number: 195061

## 8 CHANNEL DIGITAL VIDEO RECORDERS

### TECHNICAL DATA

- Channels: 8
- Compression format: H.265
- Video system: NTSC/PAL
- Operation system: Linux- embedded
- Analog video-input /output: 8CH inputs / VGA and HDMI output
- IP Video Input: 4ch (only IP up to 12ch)
- Composite video input: up to 12ch (Analog video + IP video)
- Audio input /output: 1CH input /1CH output(RCA)
- Display resolution: Analog :1080N/720P/960H, IP:1080P/720P
- Display feature: 1/4/6/8/9/10/13/14S.E.Q.
- Record resolution: Analog :1080N/720P/960H, IP:1080P/720P
- Maximum input bandwidth: 16Mbps~32Mbps (default is 8Mbps, decrease one Analog channel can increase 4Mbps)
- Maximum output bandwidth: 32Mbps
- Maximum decode performance: 1080N:120fps
- Recording mode: Continuous/Manual/ Motion detect
- Network type: Lan, DHCP, and DDNS
- HDD interface: 1SATA HDD, up to 6TB
- Multiplex operation: live display, record, playback, backup and network
- USB: 2xUSB(for mouse and backup/upgrade)
- PTZ control: yes (RS485)
- Mobile surveillance: Support Mobile Phones based on iPhone and Android operation system
- VGA/HDMI: 1024\*768,1280\*1024,1440\*900, 1920\*1080
- Power supply: DC 12V/2A
- Dimension(WxDxH): 300x227x53mm
- Working temperature: -10°C~+55°C
- Working humidity: 10%~90%



**3 YEARS TOTAL WARRANTY**  
+ 3 standard  
0 extended



## DVR AND CAMERA ACCESSORIES - CABLE SPLITTERS



1 to 4 or 1 to 8 power splitter power cable (power splitter connection).  
Plug and play ready only for camera with DC power .  
For adapting power supply 12V2A.

Catalogue number	Description	Power source type	Packing/Box (pcs)
195062	1-4 cable splitter	DC	1
195063	1-8 cable splitter	DC	1



## DVR AND CAMERA ACCESSORIES- POWER ADAPTOR



High quality supply for DVR cameras with over current protection, over voltage protection, overload protection and short-circuit protection.

Catalogue number	Description	Input Voltage	Output Voltage	Current	Packing/Box (pcs)
195065	Power adaptor	100-240V AC	12V DC	2A	1



## DVR AND CAMERA ACCESSORIES- BNC CABLE



BNC video and power security camera cable. Suitable just for camera with DC power and supply DC power for security cameras.

Plug and play connectors on both ends.

It is used for CCTV cameras, DVRs, audio video systems. Compatible with all CCTV surveillance DVR camera system.

Catalogue number	Description	Length (m)	Packing/Box (pcs)
195064	BNC cable	18.29	1



# VIDEO DOOR SYSTEMS



## WIRELESS & VIDEO DOOR PHONES



Catalogue number: 195081

### WIRELESS AND VIDEO DOOR PHONE, FOUR WIRE

When someone presses the call button on the outdoor unit, the indoor unit will ring and the mobile phone will get a notification, open the APP, you will get the video image immediately. You can unlock the door strike remotely by APP, or unlock by the indoor unit.

**CONTROL:** From Anywhere via Smart Device or via touch screen devices.

#### FUNCTION

- Video recording & photo taking
- Free iOS and Android mobile App Tuya
- Outdoor unit: password, IC card and fingerprint unlock
- Night vision

Download Tuya Application.

Full info for the products, instructions, can be found at [www.elmarkholding.eu](http://www.elmarkholding.eu).



1080P  
HD



Intercom



Smart  
Linkage



IC card  
Unlock



Fingerprint  
Unlock



Password  
Unlock



Night  
Vision



Monitoring



App  
Based

#### TECHNICAL DATA

- Input voltage: 100-240V AC
- Output: 12 V DC / 1-2A
- Power consumption indoor unit:
  - > Static state: < 4W
  - > Working state: < 8W
- Power consumption outdoor unit:
  - > Static state: < 0.5W
  - > Working state: < 6W
- Screen resolution: 1024x600 / 1080P
- Camera pixels: 2 million / 1080P
- Volume: ≥ 75dB (0.3m)
- Application: Tuya app
- Material: ABS V0
- Operation temperature: from -10 to 50°C
- Operation humidity: 10 - 90%
- Dimensions indoor unit (LxWxH): 215 x 18 x 152 mm
- Dimensions outdoor unit (LxWxH): 75 x 37 x 197 mm

Scan and watch  
detailed video  
with all product  
functions.



#### Fingerprint Unlock

Semiconductor fingerprint recognition improves reliability and efficiency



#### Weatherproof

Suitable for outdoor use



#### Night vision camera

Capture clear image even at night

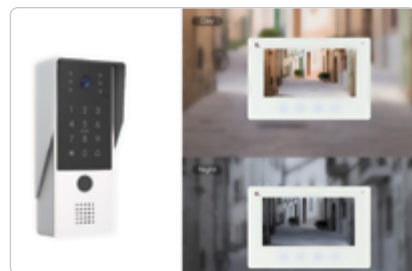

**3 YEARS TOTAL WARRANTY**  
+ 3 standard  
0 extended

## WIFI SMART VIDEO INTERCOM DOORBELL SYSTEMS, ONE UNIT WITH THREE BUTTONS AND THREE MONITORS



Catalogue number: 195085

See, hear and speak to visitors from anywhere



When someone presses the call button on the outdoor unit, the indoor unit will ring and the mobile phone will get a notification, open the APP, you will get the video image immediately. You can unlock the door strike remotely by APP, or unlock by the indoor unit.

**CONTROL:** From Anywhere via Smart Device or via touch screen devices.

### FUNCTION

- AHD, 3 families
- Tuya APP remote control
- 7 inch screen,
- Screen resolution 1024\*600
- 1080P camera
- 4-wire connection between the outdoor station and monitor
- Hand free indoor monitor
- Water-proof, anti-oxidation and anti-vandal outdoor unit.
- Electric-lock releasing function; it can open 2 doors
- Outdoor monitoring function
- Outdoor unit tags reader function
- 16 ringtones for option
- Adjustable chroma, brightness, ringing and talking volume. Enclosed with bracket, screws, adapter for DIY installation

Download Tuya Application.

Full info for the products, instructions, can be found at [www.elmarkholding.eu](http://www.elmarkholding.eu).

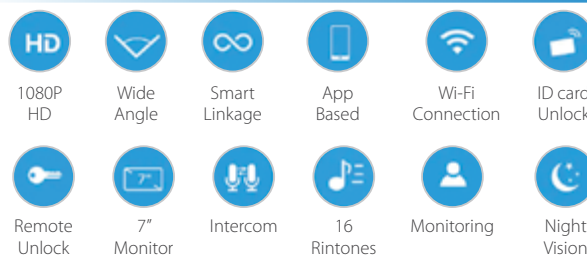

### TECHNICAL DATA

- Input voltage: 100-240V AC
- Output: 12 V DC / 1-2A
- Wire: 4
- Power consumption indoor unit:
  - > Static state: < 3.5W
  - > Working state: < 8W
- Power consumption outdoor unit:
  - > Static state: < 1W
  - > Working state: < 5W
- Screen resolution: 1024x800 / 1080P
- Camera pixels: 2 million / 1080P
- Volume: ≥ 75dB (0.3m)
- Application: Tuya app
- Material: ABS V0
- Operation temperature: from -10 to 50°C
- Operation humidity: 10 - 90%
- Dimensions indoor unit (LxWxH): 215 x 18 x 152 mm
- Dimensions outdoor unit (LxWxH): 75 x 37 x 197 mm

Scan and watch detailed video with all product functions.



#### Way to unlock

- Quick access with ID card
- Concern for elderly and kids



#### Weatherproof

Suitable for outdoor use



#### Night vision camera

Capture clear image even at night



**3 YEARS TOTAL WARRANTY**  
+ 3 standard  
0 extended

## 7 INCH WIFI SMART VIDEO INTERCOM DOORBELL SYSTEMS, DOUBLE WAY- ONE UNIT WITH ONE BUTTON AND TWO, THREE AND FOUR MONITORS, FOUR WIRE



When someone presses the call button on the outdoor unit, the indoor unit will ring and the mobile phone will get a notification, open the APP, you will get the video image immediately. You can unlock the door strike remotely by APP, or unlock by the indoor unit.

**CONTROL:** From Anywhere via Smart Device or via touch screen devices.

### FUNCTION

- Tuya APP remote control
- 7 inch screen, screen resolution 1024\*600
- 1080P AHD camera
- 4-wire connection between the outdoor station and monitor
- Hand free indoor monitor
- Water-proof, anti-oxidation and anti-vandal outdoor unit.
- Electric-lock releasing function; it can open 2 doors
- Outdoor monitoring function
- Outdoor unit tags reader function
- 16 ringtones for option
- Adjustable chroma, brightness, ringing and talking volume. Enclosed with bracket, screws, adapter for DIY installation.

Scan and watch detailed video with all product functions.



Download Tuya Application.

Full info for the products, instructions, can be found at [www.elmarkholding.eu](http://www.elmarkholding.eu).

See, hear and speak to visitors from anywhere

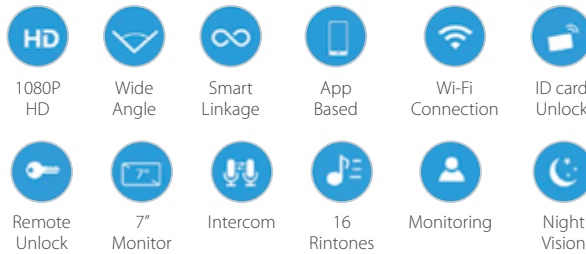

### TECHNICAL DATA

- Input voltage: 100-240V AC
- Output: 12 V DC / 2A
- Power consumption indoor unit:
  - > Static state: < 3.5W
  - > Working state: < 8W
- Power consumption outdoor unit:
  - > Static state: < 1W
  - > Working state: < 5W
- Screen resolution: 1024x600/ 1080P
- Camera pixels: 2 million/ 1080P
- Volume: ≥ 75dB (0.3m)
- Application: Tuya app
- Material: ABS V0
- Operation temperature: from -10 to 50°C
- Operation humidity: 10 - 90%
- Dimensions indoor unit (LxWxH): 215 x 18 x 152 mm
- Dimensions outdoor unit (LxWxH): 52 x 47 x 130 mm

**Weatherproof**  
Suitable for outdoor use



**Night vision camera**  
Capture clear image even at night



Catalogue number	Model	Description	Input voltage	Screen
195080	EL-WF1DP+1	Single way intercom with 2 monitors	100-240V AC	2x7 inches
195076	EL-WF1DP+2	Single way intercom with 3 monitors	100-240V AC	3x7 inches
195078	EL-WF1DP+3	Single way intercom with 4 monitors	100-240V AC	4x7 inches

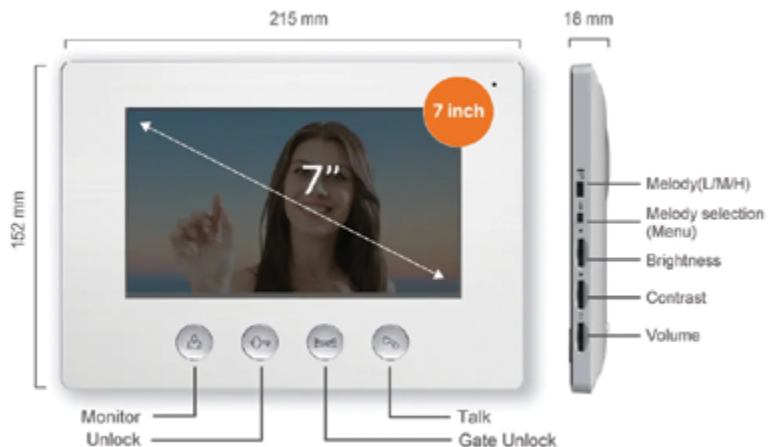

**3 YEARS TOTAL WARRANTY**  
+ 3 standard 0 extended



Catalogue number: 195082

## SMART PHOTO DOORBELL CAMERA WITH WIRELESS CHIME, TUYUA

When someone presses the call button on the outdoor unit, the indoor unit will ring and the mobile phone will get a notification, open the APP.

**CONTROL:** From Anywhere via Smart Device.

### FUNCTION

- Motion- and ring-triggered smart phone notifications with recorded images.
- See visitors' photo via mobile phone from any place.
- Free Cloud storage, view the photos for 3\*24 hours for free.
- Work as a normal door chime when smart phone is not nearby or turned off.
- Night vision camera, resolution is 640 x 480.
- Motion detection sensitivity adjustable, motion detection Range is 3m and 70°.
- Camera viewing angle is around 70°.
- Powered by 3xLR6 batteries (not included) for easy installation.
- Bluetooth network configuration.
- Waterproof: IPX4.

Download Tuuya Application.  
Full info for the products, instructions, can be found at [www.elmarkholding.eu](http://www.elmarkholding.eu).



Scan and watch detailed video with all product functions.



**3 YEARS TOTAL WARRANTY**  
+ 3 standard  
0 extended

### Two ways to activate



Ring Alert

Motion Alert



See who is at your front door from your smartphone

Get notified in your home when guest arrives

### Weatherproof

Suitable for outdoor use



### Night vision

Doorbell camera sends motion-photos to your phone

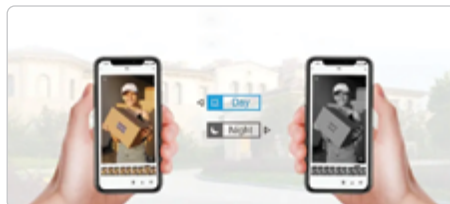

### AA Rated & Powered

Powered by three AA batteries for both - camera and indoor chime



### DOORBELL TECHNICAL DATA

- Battery: DC 4.5V AA/LR6 x 3
- Wireless distance: ≤ 80m (open area)
- PIR angle: 70°
- Camera viewing angle: 70°
- Camera pixels: 350 000
- Waterproof rating: IP45
- Operation temperature: from -20 to 50°C
- Operation humidity: 10 - 90%
- Dimensions outdoor unit (LxWxH): 51 x 20 x 126 mm

### CHIME TECHNICAL DATA

- Battery: DC 4.5V AA/LR6 x 3
- Wireless distance: ≤ 80m (open area)
- Standby average current: < 200uA
- Operating average current: < 100mA
- Volume: Low 60-70dB / Medium 70-80dB / High 80-90dB
- Operation temperature: from -10 to 50°C
- Dimensions indoor unit (LxWxH): 78 x 30 x 78 mm

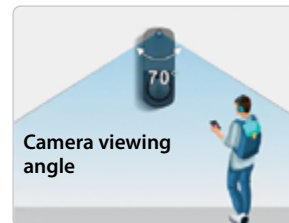
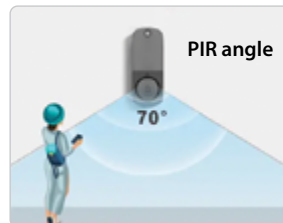



Catalogue number: 195083

## SMART WIRELESS VIDEO DOORBELL, TUYA

When someone presses the call button on the outdoor unit, the indoor unit will ring and the mobile phone will get a notification, open the APP.

**CONTROL:** From Anywhere via Smart Device.

### FUNCTION

- When the visitor pressed the doorbell, the indoor unit will give an alert tone.
- PIR detection: When someone is near the door, the doorbell will be woken up
- Two-way audio
- High volume wireless indoor chime
- Long time standby
- Night vision camera, resolution is 640 x 480.
- Motion detection sensitivity adjustable, motion detection range is 3m and 110°.
- Camera viewing angle is around 110°.
- Waterproof: IPX4.

Download Tuya Application.

Full info for the products, instructions, can be found at [www.elmarkholding.eu](http://www.elmarkholding.eu).

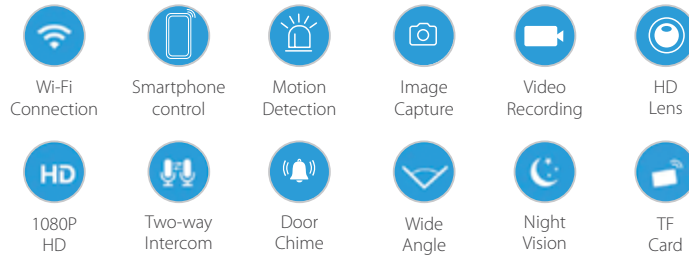

### Three ways to activate

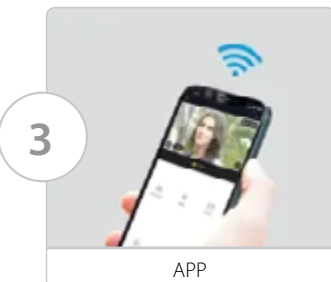
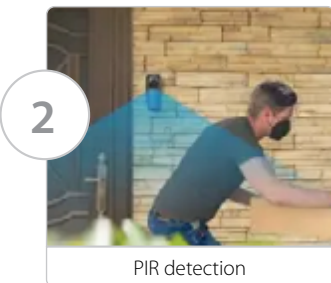
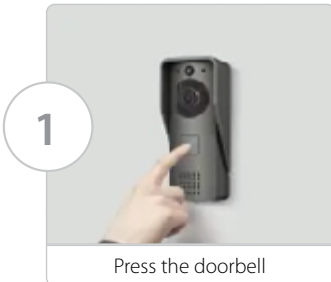

### DOORBELL TECHNICAL DATA

- Video resolution: 2M Pixels
- Wireless distance: ≤ 80m (open area)
- PIR angle: 110°
- Camera viewing angle: 110°
- Video recording length: 15 sec
- Standby current: 1.5mA
- Intercom volume: 80dB
- Alarm volume: 85dB
- Waterproof rating: IP45
- Operation temperature: from -10 to 50°C
- Operation humidity: 10 - 90%
- Dimensions outdoor unit (LxWxH): 56.8x40.5x159.5 mm

### CHIME TECHNICAL DATA

- Battery: DC 4.5V AA/LR6 x 3
- Wireless distance: ≤ 80m (open area)
- Standby average current: < 0.25mA
- Operating average current: < 100mA
- Volume: > 85dB
- Operation temperature: from -10 to 50°C
- Dimensions indoor unit (LxWxH): 65x29.5x95 mm



Scan and watch detailed video with all product functions.



### Wide-angle view outside the door at a glance

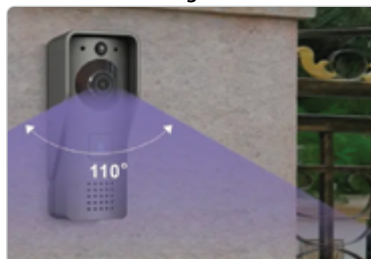

### Screen snapshot, Video recording

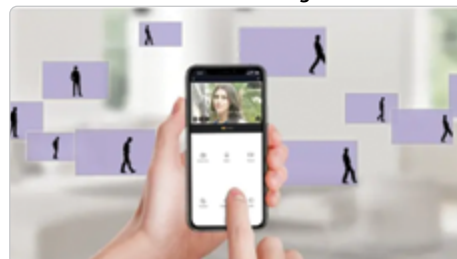

**3 YEARS TOTAL WARRANTY**  
+ 3 standard  
0 extended



Catalogue number: 195084

## SOLAR VIDEO SMART WIRELESS DOORBELL, TUYA

When someone presses the call button on the outdoor unit, the indoor unit will ring and the mobile phone will get a notification, open the APP.

**CONTROL:** From Anywhere via Smart Device.

### FUNCTION

- 1080P camera resolution, 110° in horizontal viewing angle
- See and speak to visitors via smart mobile APP from any place
- Work as a normal door chime when smart phone is not nearby or turned off
- Built-in Lithium batteries. Not limited by the outdoor power supply.
- Built-in motion sensor triggers mobile alerts
- Take photos by smart mobile via APP
- Video Recording : support TF card recording (max :64GB)
- Built-in night vision to capture activity around the door at night
- IP44 weatherproof.

### Wide-angle view outside the door at a glance

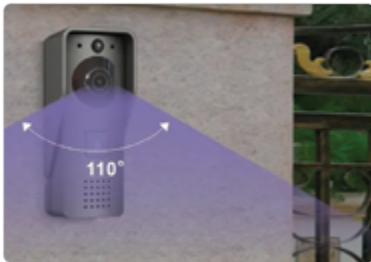

Download Tuya Application.

Full info for the products, instructions, can be found at [www.elmarkholding.eu](http://www.elmarkholding.eu).



Wi-Fi Connection



Smartphone control



Remote Unlock



Motion Detection



Image Capture



Video Recording



HD Lens



1080P HD



Two-way Intercom



Door Chime



Wide Angle



Night Vision



TF Card

### Screen snapshot, Video recording



### DOORBELL TECHNICAL DATA

- Support solar power supply
- Video resolution: 2M Pixels
- Wireless distance: ≤ 80m (open area)
- PIR angle: 110°
- Camera viewing angle: 110°
- Video recording length: 15 sec
- Standby current: 1.5mA
- Intercom volume: 80dB
- Alarm volume: 85dB
- Waterproof rating: IP45
- Operation temperature: from -10 to 50°C
- Operation humidity: 10 - 90%
- Dimensions outdoor unit (LxWxH): 56.8 x 40.5 x 159.5 mm / Dimensions solar panel(LxWxH): 153x 10 x 139 mm

### CHIME TECHNICAL DATA

- Battery: DC 4.5V AA/LR6 x 3
- Wireless distance: ≤ 80m (open area)
- Standby average current: < 200uA
- Operating average current: < 100mA
- Volume: Low 60-70dB / Medium 70-80dB / High 80-90dB
- Operation temperature: from -10 to 50°C
- Dimensions indoor unit (LxWxH): 78x30x78 mm

### Equipped with high volume wireless indoor chime



Scan and watch detailed video with all product functions.

### Smart tamper alarm



### PIR detection



**3 YEARS TOTAL WARRANTY**  
+ 3 standard  
0 extended





Cat. Number: M160132

## ELECTROMAGNETIC STRIKE PLATES 6-12V AC/DC

### APPLICATION

For remote open left and right hand doors.

### FEATURES

- Universal- without specific direction of opening.
- Adjustable tongue with movement 4 mm.
- Supply voltage: 6-12V AC/DC
- Fail secure- with mechanical release lever
- Compatible with 12V intercom system
- Strike plate from Zink finished steel

### THE SET INCLUDES

- 1 Electromagnetic Strike
- 1 Front plate
- Fasteners

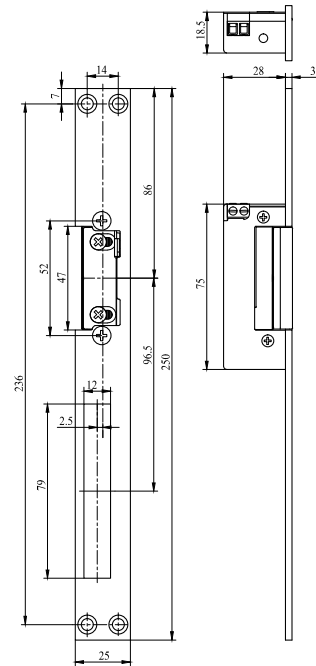
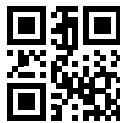

Cat. Number: M160133

## ELECTROMAGNETIC STRIKE PLATES 8-16V AC/DC

### APPLICATION

For remote open left and right hand doors.

### FEATURES

- Universal- without specific direction of opening.
- Adjustable tongue with movement 3 mm.
- Supply voltage: 8-16V AC/DC
- Compatible with 12V intercom system
- Universal without memory and block.
- NC contact (Fail secure): remains locked in the absence of voltage.
- Strike plate from Zink finished steel

### THE SET INCLUDES

- 1 Electromagnetic Strike
- 1 Front plate
- Fasteners

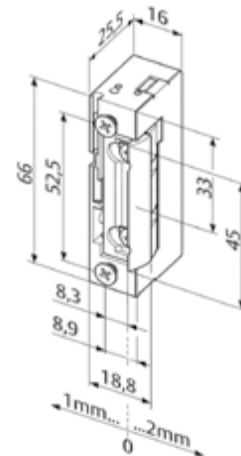

**2 YEARS TOTAL WARRANTY**  
+ 2 standard  
0 extended



Cat. Number: 196005

## SMART SECURITY DOUBLE CYLINDER RIM DOOR LOCK EL-ERSP2, WHITE

A Rim Lock is the oldest type of locking device for a door. Its basic design comprises a surface mounted box containing a deadbolt type of lock and a latch. Rim locks are easy to fit as they are fixed to the surface of the door.

### FEATURES

- High-quality components
- Double connected cylinders
- With strike plate
- Can be connected Access Control System
- Suitable for: Metal door, wooden door, Stainless steel door.



### TECHNICAL DATA

- Type: Security smart double cylinder rim door lock 12V DC
- Model: EL-ERSP2
- Locking method: Collision lock
- Input voltage: 12V DC
- Unlock voltage: 6-15V
- Unlock current: 1.5-3A
- Sensitivity: 1s
- Mechanical life: 500 000 times
- Material: Iron
- Surface treatment: Power Spraying, Electroplating
- Mounting: Surface mounting on the inside of the door
- Dimensions (LxWxH): 122x105x35mm

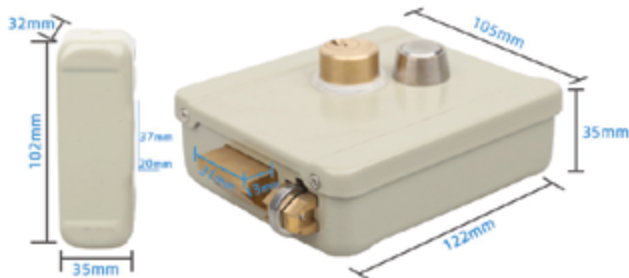

**3 YEARS TOTAL WARRANTY**  
+ 3 standard  
0 extended



### Cylinder

Copper solid mechanical lock core, can withstand wear and tear, and has a long service life.



### Lock structure

Fixed circlip, smart anti-theft, high elasticity spring, thickened lever, security and peace of mind.

# SMART DOOR LOCKS



SMART DOOR LOCKS

**FINGERPRINT ELECTRONIC SMART DOOR LOCK EL-T1**

EL-T1 is smart digital door lock with small size and 5 ways to unlock- fingerprint, password, card, key and APP via Bluetooth.



**CONTROL:** Local

**FEATURES**

- Small size
- Multiple ways to unlock: fingerprint, code, card, mechanical key, mobile APP
- Stylish and simple design
- High sensitive fingerprint
- Anti-pry alarm
- Light indicator: Indicate the smart lock status and help to find at night.
- Anti-copy encrypted card: Intelligent encryption IC card recognition, easy to manage, high security against copying.
- Powerful inner core: high- performance chip, more accurate running speed algorithm.



Multiple ways to unlock



Voice control



High sensitive fingerprint



Anti-pry alarm



USB emergency interface



Virtual password

Download TTLOCK Application.

Full info for the products, instructions, can be found at [www.elmarkholding.eu](http://www.elmarkholding.eu)

**Remotely unlock by mobile APP**

With powerful mobile app functions

**3 YEARS TOTAL WARRANTY**  
+ 3 standard  
0 extended

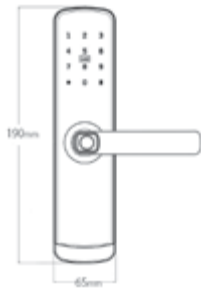

**TECHNICAL DATA**

- Material: Aluminum alloy
- Power supply: 4x1.5V AA batteries- Not included
- Charging input: Type C
- Suitable mortise: ST-5050
- Alert voltage: 4.8V
- Static current: 65 uA
- Induction time: ≤ 0.5s
- False reject rate: ≤ 0.01%
- False acceptance rate: ≤0.0001%
- Fingerprint capacity: 100
- Password capacity: 50
- Card capacity: 100
- Password length: 6-12 digits
- Door thickness: 30-120mm
- Dimensions (LxH): 65x190mm

**THE SET INCLUDES:**

- Smart door lock: 1pc
- IC card: 3pcs
- Mechanical keys: 2pcs

Catalogue number	Fingerprint capacity	Password capacity	Card capacity	Door thickness	Suitable mortise	Packing/Box (pcs)
195011	100	50	100	30-120mm	5050	1

Scan and watch detailed video with all product functions.



**Anti-copy encrypted card**

Intelligent encryption IC card recognition, easy to manage, high security against copying.

**Full auto lock body**

Automatic lock body, with built-in motor more convenient and safer.

**Two ways to open the door**

Digital anti-thief lock

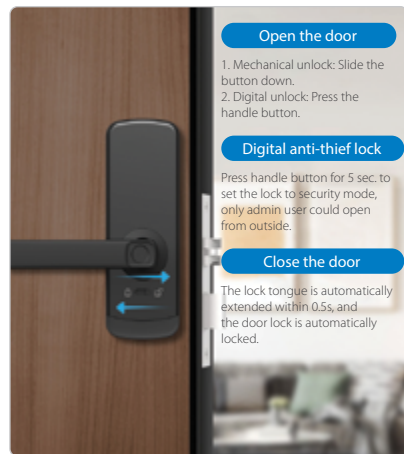
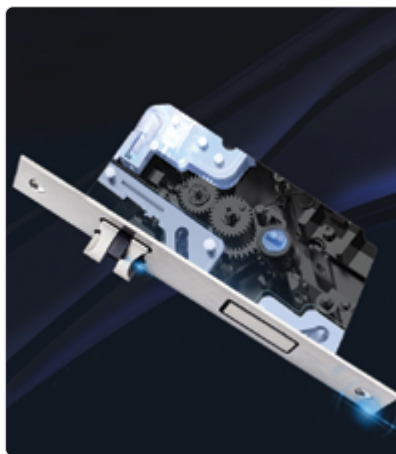

**3 YEARS TOTAL WARRANTY**  
+ 3 standard 0 extended





## FINGERPRINT ELECTRONIC SMART DOOR LOCK EL-T2

EL-T2 is smart digital door lock with small size and 5 ways to unlock- fingerprint, password, card, key and APP via Bluetooth.

**CONTROL:** Local

### FEATURES

- Small size
- Multiple ways to unlock: fingerprint, code, card, mechanical key, mobile APP
- Stylish and simple design
- High sensitive fingerprint
- Anti-pry alarm
- Light indicator: Indicate the smart lock status and help to find at night.
- Anti-copy encrypted card: Intelligent encryption IC card recognition, easy to manage, high security against copying.
- Powerful inner core: high- performance chip, more accurate running speed algorithm.



Multiple ways to unlock



Voice control



High sensitive fingerprint



Anti-pry alarm



USB emergency interface



Virtual password

Download TTLOCK Application.

Full info for the products, instructions, can be found at [www.elmarkholding.eu](http://www.elmarkholding.eu)

### Remotely unlock by mobile APP

With powerful mobile app functions

**TTLOCK APP**

- Bluetooth Access
- Wifi unlock remotely
- Ekey management
- Pin code management
- Authorized admin
- Wireless key fob
- Remaining batteries/ Volume Setting/ system upgrade & more
- Unlock history
- Manage fingerprint users
- Manage card users
- Send E-Key by SMS
- Share pincode by SMS

**3 YEARS TOTAL WARRANTY**  
+ 3 standard  
0 extended

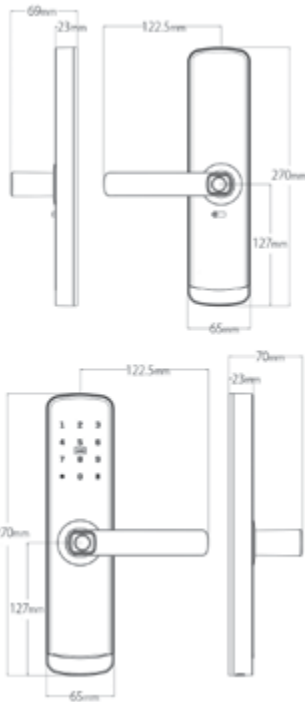

**TECHNICAL DATA**

- Material: Aluminum alloy
- Power supply: 4x1.5V AAA batteries - not included
- Charging input: Type C
- Suitable mortise: ST-7255
- Alert voltage: 4.8V
- Static current: 65 uA
- Induction time: ≤ 0.5s
- False reject rate: ≤ 0.01%
- False acceptance rate: ≤ 0.0001%
- Fingerprint capacity: 120
- Password capacity: 150
- Card capacity: 200
- Password length: 6-12 digits
- Door thickness: 30-120mm
- Dimensions (LxH): 65x270mm

**THE SET INCLUDES:**

- Smart door lock: 1pc
- IC card: 3pcs
- Mechanical keys: 2pcs

Catalogue number	Fingerprint capacity	Password capacity	Card capacity	Door thickness	Suitable mortise	Packing/Box (pcs)
195007	120	150	200	30-120mm	7255	1



Scan and watch detailed video with all product functions.

**Anti-copy encrypted card**

Intelligent encryption IC card recognition, easy to manage, high security against copying.

**Scramble pin code technology**

Protective inputting, unlocking with ease no more concern about being peeped.

**High sensitive fingerprint**

AI self-learning algorithm, anti-copy, anti-theft, fast identification within 0.5 seconds.

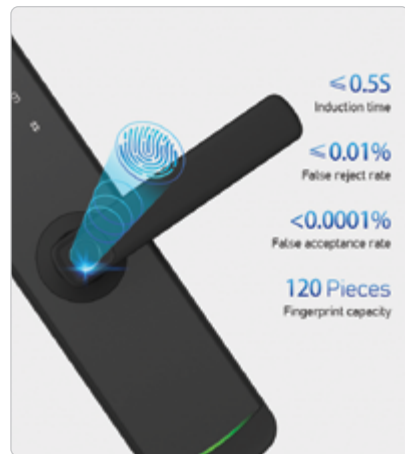

**3 YEARS TOTAL WARRANTY**  
+ 3 standard 0 extended

## FINGERPRINT ELECTRONIC SMART DOOR LOCK EL-T6

EL-T6 is smart digital slim door lock with 5 ways to unlock- fingerprint, password, card, key and APP. With two various models of mortise for option, it's very suitable for aluminum doors, wooden doors and other metal doors.

**CONTROL:** Local

### FEATURES

- Slim body design
- Multiple ways to unlock: fingerprint, code, card, mechanical key, mobile APP
- Stylish and simple design
- High sensitive fingerprint
- Multiple alarming function
- Light indicator: Indicate the smart lock status and help to find at night.
- Micro USB emergency power
- Anti-copy encrypted card: Intelligent encryption IC card recognition, easy to manage, high security against copying.
- Powerful inner core: high- performance chip, more accurate running speed algorithm.



Multiple ways to unlock



Voice control



High sensitive fingerprint



Anti-pry alarm



USB emergency interface



Virtual password

Download *TTLOCK* Application.

Full info for the products, instructions, can be found at [www.elmarkholding.eu](http://www.elmarkholding.eu)

### Compatible with various type of doors



▲ Aluminum door



▲ Wooden door



▲ Framed door



▲ Sliding door

**3 YEARS TOTAL WARRANTY**  
+ 3 standard  
0 extended



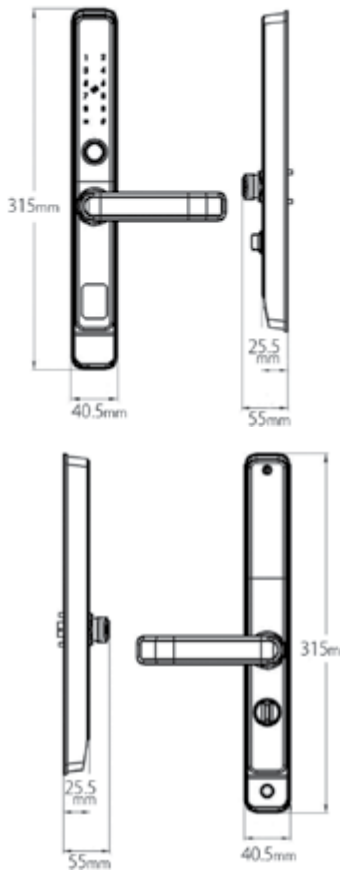

**TECHNICAL DATA**

- Material: Aluminum alloy
- Power supply: 4x1.5V AA batteries - not included
- Charging input: Type C
- Suitable mortise: ST-3585 & ST-5085
- Alert voltage: 4.8V
- Static current: 65 uA
- Induction time: ≤ 0.5s
- False reject rate: ≤ 0.01%
- False acceptance rate: ≤ 0.0001%
- Fingerprint capacity: 120
- Password capacity: 150
- Card capacity: 200
- Password length: 6-12 digits
- Door thickness: 40-120mm
- Dimensions (LxH): 36x310mm
- IP code: IPX5 Waterproof

**THE SET INCLUDES:**

- Smart door lock: 1pc
- IC card: 3pcs
- Mechanical keys: 2pcs

Catalogue number	Fingerprint capacity	Password capacity	Card capacity	Door thickness	Suitable mortise	Packing/Box (pcs)
195008	120	150	200	40-120mm	5085	1
195009	120	150	200	40-120mm	3585	1



Scan and watch detailed video with all product functions.

**Powerful inner core, Smart CPU**  
Stable operating system, high performance chip.

**0.5s** UNLOCK TIME  
Self-optimization Algorithm

**100ms** RESPONSE TIME  
Integrate Security and IoT Connectivity

**INSIDE SECURITY KNOB**

When turn on this knob, the lock can be unlocked only by mechanical keys from outside.

**IPX5 WATERPROOF**

**Easy to install and replace the battery**

**LOW BATTERY REAL-TIME REMINDER**

With USB emergency port for charging to unlock.

TIPS: Replace the batteries after low battery reminder.

Smart power saving 10000 times of operation

4x1.5V AAA Batteries

**3 YEARS TOTAL WARRANTY**  
+ 3 standard 0 extended



## FINGERPRINT ELECTRONIC SMART GLASS DOOR LOCK EL-G3

EL-G3 is smart digital door lock with small size and 5 ways to unlock- fingerprint, password, card, key and APP via Bluetooth. EL-G3 is designed for frame-less glass doors.

**CONTROL:** Local

### FEATURES

- Small size
- Integrated doorbells
- Multiple ways to unlock: fingerprint, code, card, mechanical key, mobile APP
- Stylish and simple design
- High sensitive fingerprint
- Alarming Function when the door is not close well or low power, wrong operation
- Anti-copy encrypted card: Intelligent encryption IC card recognition, easy to manage, high security against copying.
- Powerful inner core: high- performance chip, more accurate running speed algorithm.



Multiple ways to unlock



Voice control



High sensitive fingerprint



Anti-pry alarm



USB emergency interface



Virtual password

Download TTLOCK Application.

Full info for the products, instructions, can be found at [www.elmarkholding.eu](http://www.elmarkholding.eu)

**Remotely unlock by mobile APP**  
With powerful mobile app functions

- Share pincode by SMS
- Send E-Key by SMS
- Manage card users
- Manage fingerprint users
- Unlock history

**TTLOCK APP**

- Bluetooth Access
- Wifi unlock remotely
- Ekey management
- Pin code management
- Authorized admin
- Wireless key fob
- Remaining batteries/ Volume Setting/ system upgrade & more

### Anti-copy encrypted card

Intelligent encryption IC card recognition, easy to manage, high security against copying.

- Encryption protection
- Two-step verification
- Lost and void

### Scramble pin code technology

Protective inputting, unlocking with ease no more concern about being peeped.

### High sensitive fingerprint

AI self-learning algorithm, anti-copy, anti-theft, fast identification within 0.5 seconds.

- <math>< 0.5s</math> Induction time
- <math>< 0.01\%</math> False reject rate
- <math>< 0.0001\%</math> False acceptance rate
- 200 Pieces Fingerprint capacity

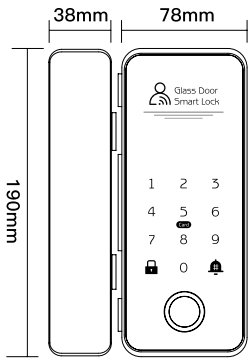

**TECHNICAL DATA**

- Material: Aluminum alloy
- Power supply: 4x1.5V AAA batteries - not included
- Charging input: Type C
- Alert voltage: 4.8V
- Static current: 65 uA
- Induction time: ≤ 0.5s
- False reject rate: ≤ 0.01%
- False acceptance rate: ≤ 0.0001%
- Fingerprint capacity: 200
- Password capacity: 150
- Card capacity: 200
- Password length: 6-12 digits
- Door thickness: 8-12mm

**THE SET INCLUDES:**

- Smart door lock: 1pc
- IC card: 3pcs
- Mechanical keys: 2pcs

Catalogue number	Fingerprint capacity	Password capacity	Card capacity	Door thickness	Packing/Box (pcs)
195010	200	150	200	8-12mm	1

Scan and watch detailed video with all product functions.



**3 YEARS TOTAL WARRANTY**  
+ 3 standard  
0 extended



## BLUETOOTH TUYA FINGERPRINT WIRELESS DOOR LOCK EL-M10

EL-M10 is semiconductor smart door lock with 4 ways to unlock- fingerprint, password, key and APP

**CONTROL:** Local

### FEATURES

- Small size
- Multiple ways to unlock: fingerprint, code, mechanical key, mobile APP
- Stylish and simple design
- High sensitive fingerprint
- Anti-peeping function
- Emergency power indication
- Green light for passed certification and red light failed authentication
- Artificial intelligence learning algorithm improves recognition rate
- Rapid induction recognition- 0.25 seconds
- With USB port for emergency power
- With Backup mechanical key for emergency override

Catalogue number:195100



Multiple ways to unlock



High sensitive fingerprint



USB emergency interface



Virtual password

### TECHNICAL DATA

- Fingerprint Type: Semiconductor
- Fingerprint Capacity: 100
- Material: Zink Alloy
- Lock Cylinder level: C-level lock cylinder
- Power Supply: 4 X AAA Batteries
- Working current:  $\leq 120\text{mA}$
- Idle current:  $\leq 25\text{uA}$
- Recognition Speed: 0.25s
- Unlock Method: Fingerprint, password, TUYA, key
- Colour: Black
- Operating Temperature:  $-20^{\circ}\text{C} + 60^{\circ}$
- Applicable door type: Wooden doors, fire doors, security doors, etc
- Locking distance: can be stretched from 60 to 70mm
- Size LxH: 150x70mm

Catalogue number	Fingerprint capacity	Password capacity	Door thickness	Packing/Box (pcs)
195100	100	155	30-55mm	1

#### One touch open no need to wait

Live fingerprints are hidden on the handle. Open the door in one go.



#### Semiconductor fingerprint One key unlock

Artificial intelligence learning algorithm improves recognition rate.



**3 YEARS TOTAL WARRANTY**  
+ 3 standard  
0 extended



Catalogue number:195101



## SMART DIGITAL WIRELESS TUYA DOOR LOCK, EL-A220F

EL-A220F is smart door lock with 5 ways to unlock- fingerprint, password, IC card, key and APP

**CONTROL:** Local or via smart devices from anywhere.

### FEATURES

- Multiple ways to unlock: fingerprint, code, mechanical key, IC card, mobile APP
- Stylish and simple design
- High sensitive fingerprint
- Dead lock function
- Adjustable mounting: left or right direction
- Emergency power indication
- Green light for passed certification and red light failed authentication
- Artificial intelligence learning algorithm improves recognition rate
- Rapid induction recognition- 1 - 1.5 seconds
- With USB port for emergency power
- With backup mechanical key for emergency override



Multiple ways to unlock



High sensitive fingerprint



USB emergency interface



Virtual password

### TECHNICAL DATA

- User Capacity: 200
- Material: Aluminium Alloy
- Lock Cylinder level: C-level lock cylinder
- Power Supply: 4 X AA Batteries
- Dinamic current: ≤200mA
- Static current: ≤25uA
- Unlook Time: 1-1.5s
- Unlock Method: Fingerprint, password, TUYA, key
- Colour: Black
- Operating Temperature: -20°C + 50°
- Applicable door type: Wooden doors, fire doors, security doors, etc
- Mortise: from 60 to 70mm adjustable deadbolt mortise
- Door thickness: 35-55mm

### SET INCLUDED

- Front panel- 1pc
- Back panel- 1pc
- Deadbolt latch- 1pc
- Strike plate- 1pc
- Strike box- 1pc
- Screws for fixing
- Entry cards- 2pcs
- Mechanical key- 2pcs

Catalogue number	Fingerprint capacity	Password capacity	Door thickness	Packing/Box (pcs)
195101	200	200	30-55mm	1



**3 YEARS TOTAL WARRANTY**  
+ 3 standard  
0 extended

## SMART FINGERPRINT WIRELESS TUYA DOOR CYLINDER, EL-S1F

EL-S1F is smart door cylinder with 4 ways to unlock- fingerprint, IC card, key and APP

**CONTROL:** Local or via smart devices from anywhere.

### FEATURES

- Multiple ways to unlock: fingerprint, mechanical key, IC card, mobile APP
- Stylish and simple design
- High sensitive fingerprint
- Dead lock function
- Emergency power indication
- Green light for passed certification and red light failed authentication
- Rapid induction recognition- 1 - 1.5 seconds
- With USB port type-C for emergency power
- With backup mechanical key for emergency override



Catalogue number: 195106



Multiple ways to unlock



High sensitive fingerprint



USB emergency interface



Virtual password

### TECHNICAL DATA

- Fingerprint Capacity: 100
- Material: Aluminum Alloy
- Power Supply: CR123A Battery
- Unlock Time: 1-1.5s
- Unlock Method: Fingerprint, password, TUYA, key
- Colour: Black
- Operating Temperature: -20°C + 50°
- Applicable door type: Wooden doors, fire doors, security doors, etc
- Door thickness: 30-50mm
- Cylinder lock size (A+B): 30+30mm
- Total length: 60mm

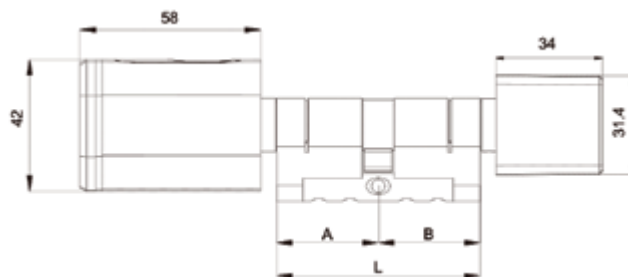

Catalogue number	Fingerprint capacity	Password capacity	Door thickness	Packing/Box (pcs)
195106	100	100	30-50mm	1

### SET INCLUDED

- Smart lock- 1pc
- Mounting tools
- Entry cards- 2pcs
- Mechanical key- 2pcs



**3 YEARS TOTAL WARRANTY**  
+ 3 standard  
0 extended

## WATERPROOF TUYA FINGERPRINT BLUETOOTH PADLOCK, EL-ILOCK

This smart padlock is suitable for house doors, warehouse, cabinet, offices and etc.

### TECHNICAL DATA

- Type: Smart padlock, support TUYA
- Model: EL-ILOCK
- Material: Metal
- Charging: USB 5V
- Battery: 300mAh Li-Ion
- Unlock speed: 0.5s
- Unlock time length: 5s
- Fingerprint storage: 10 users
- IP code: IP54
- Working temperature: from -10°C to 50°C
- Dimensions (LxH): 36x29mm

IP54

Li-ion



Catalogue number:196004



Scan and watch detailed video with all product functions.

### Fingerprint unlock

Safe convenient  
0.5s unlock



### USB charge

Long standby time  
300 mAh Lithium battery

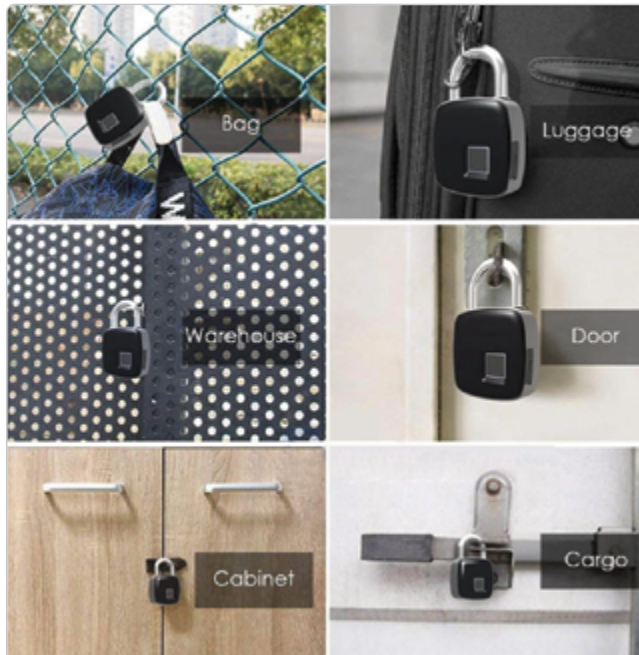
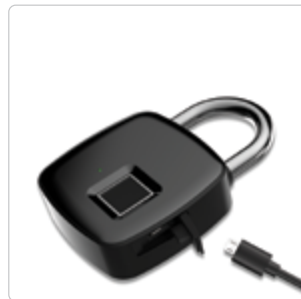

**3 YEARS TOTAL WARRANTY**  
+ 3 standard  
0 extended





The image features a teal vertical bar on the left side. To its right, a circular technical diagram is visible, composed of concentric lines and various geometric shapes, with a bright orange and yellow glow emanating from its center. The background is a light gray gradient.

# ACCESS CONTROL



Catalogue number:195093

**Original chip**

Precision electronic components.  
Stable performance.



## RFID STANDALONE ACCESS CONTROLLER WITH KEYPAD 125KHZ, EL-C02

Standalone access control is usually one or two small units wired directly onto a door panel to control access to the door. There is no need for a PC network and you don't have to secure every single door within your building, only those you wish to.

For standalone access control systems, all electronics are installed in a keypad or reader - there are no additional components or peripherals, including extra wiring, routers, sensors and alarms.

**FEATURES**

- High-quality components
- Precision electronic components with stable performance
- No user limit
- Support 1000 groups of personal passwords
- With relay output and level output for electric lock

**TECHNICAL DATA**

- Type: Standalone access controller
- Model: EL-C02
- Working frequency: 125KHz
- Card type: EM
- Capacity: 1000 users
- Card reading distance: 1-15cm
- Working voltage: 12-30V DC
- Working current: 150mA
- Working temperature: from -10°C to 55°C
- Humidity: 90% RH (non-condensing)
- Add card method: via computer
- External device port: electric lock (including relay output and level output)
- Dimensions (HxLxD): 115x70x20mm



Scan and watch detailed video with all product functions.

**3 YEARS TOTAL WARRANTY**  
+ 3 standard  
0 extended

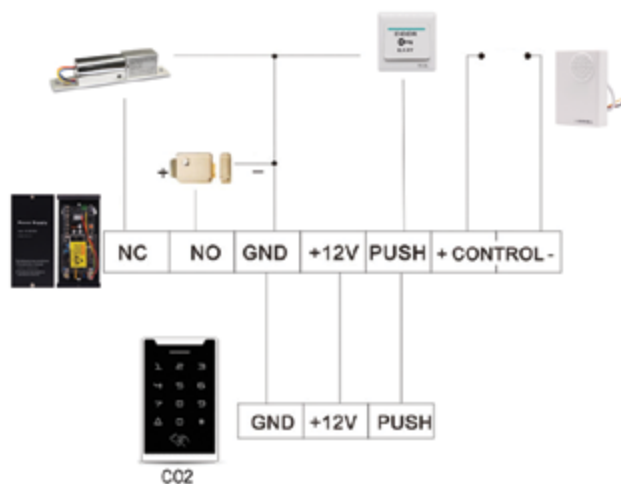
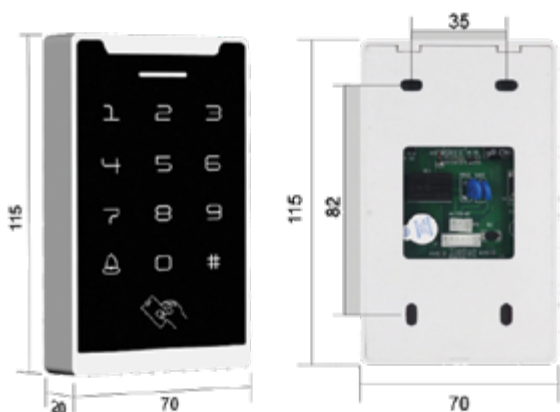



IP65

Catalogue number: 195094

## RFID STANDALONE WATERPROOF METAL ANTI-VANDAL ACCESS CONTROLLER WITH KEYPAD 125KHZ, EL-T1101

The unit is single door multifunction standalone access controller or a Wiegand output keypad or card reader. It is suitable for mounting either indoor or outdoor in harsh environments. It is housed in a strong, sturdy and vandal proof Zinc Alloy electroplated case which is available in silver. The electronics are fully defended. This unit supports up to 2000 users in either a Card, 4 digit PIN, or a Card + PIN option. The inbuilt card reader supports 125KHZ EM cards. The unit has many extra features including lock output current short circuit protection, Wiegand output, and a back light keypad. These features make the unit an ideal choice for door access not only for small shops and domestic households but also for commercial and industrial applications such as factories, warehouses, laboratories, banks and etc.

### FEATURES

- Metal case, anti-vandal
- Waterproof
- Digital back light touch keypad
- Multi-function standalone access controller and reader
- WG interface: WG26 Input / output
- Capacity: 2000 cards / codes
- Three accesses: card, pin, card + pin

### TECHNICAL DATA

- Type: Touch screen standalone access controller
- Model: EL-T1101
- Working frequency: 125KHz
- Card type: EM
- Capacity: 2000 users
- Card reading distance: 2-5cm
- Working voltage: 12-24V DC
- Static Electricity:  $\leq 35\text{mA}$
- Electric Lock Output:  $\leq 1\text{A}$
- Short-Circuit Protect:  $\leq 100\mu\text{s}$
- Relay Output Delay Time: 0-99 s
- IP code: IP65
- Working temperature: from  $-40^{\circ}\text{C}$  to  $60^{\circ}\text{C}$
- Humidity: 90% RH (non-condensing)
- Add card method: via computer
- External device port: electric lock (including relay output and level output)
- Dimensions (HxL): 135x48mm

Scan and watch detailed video with all product functions.



**3 YEARS TOTAL WARRANTY**  
+ 3 standard  
0 extended

COMMON POWER SUPPLY DIAGRAM

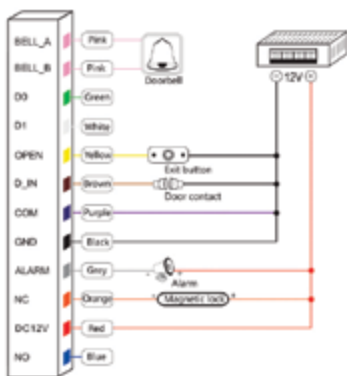

SPECIAL POWER SUPPLY DIAGRAM

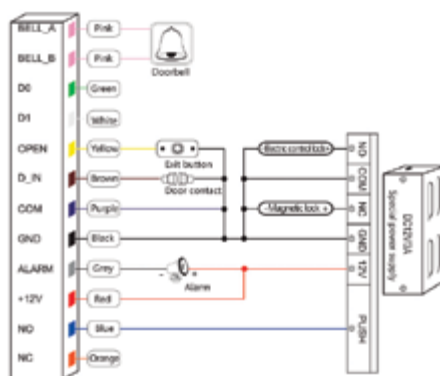

READER MODE DIAGRAM

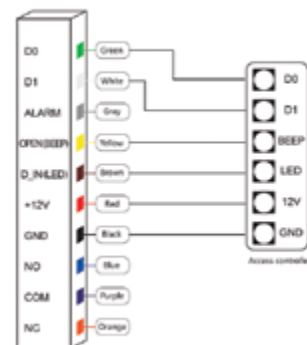



Catalogue number:195097

## STANDALONE PROXIMITY CONTROLLER FOR ACCESS CONTROL AND TIME ATTENDANCE, EL-SCR100

EL-SCR100 is an access control devices, which is made with elegant design. The device have lock control, alarm, exit button, door sensor. The wiegand-in interface is used to connect external reader to construct master and slave system. Also the device can be used to connect with a control panel as a reader by wiegand-out interface. The operation can be done on PC software and upload to the device through TCP/IP, RS232/485 communication. The USB-host is used for data download and upload, including user data and record etc.

EL-SCR100 is suitable for house, small office and factory etc.

### FEATURES

- Elegant design with Acrylic plastic
- With TCP/IP interface, avoid RS485 communication and low speed for transferring data, standalone or network deployment
- Professional access control function: 50 time zones, 5 groups, 10 open door combination, support multi users entry
- Protect the data with encrypted technology
- Built-in relay contacts lock, alarm, door sensor and exit button
- Wiegand input and output enable Master/Slaver access control
- Embedded web server: support browser to inquire access data at local or remote.

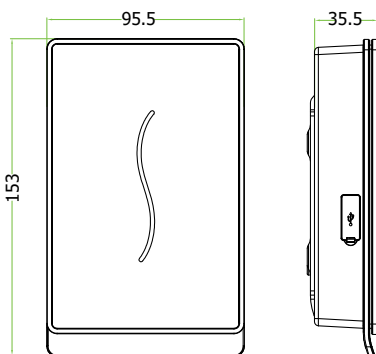

### TECHNICAL DATA

- Type: Standalone proximity controller for access control and time attendance
- Model: EL-SCR100
- Working frequency: 125KHz
- Access control Interface: 3rd party electric lock, door sensor, exit button, alarm, door bell
- Standard function: Anti-passback, webserver, 9 digital number
- Card type: EM (RFID)
- Card capacity: 30000
- Card reading distance: 5-10cm
- Transaction capacity: 50000
- Working voltage: 12V DC
- Static current: 300mA
- Wiegand signal: input and output
- Communication: TCP/IP, RS232/485, USB-Host
- Working temperature: from 0°C to 45°C
- Humidity: 20-80% RH (non-condensing)
- Material: Acrylic plastic
- Dimensions (LxHxD): 95.5x153x35.5mm



Scan and watch detailed video with all product functions.

**3 YEARS TOTAL WARRANTY**  
+ 3 standard  
0 extended

### Configuration

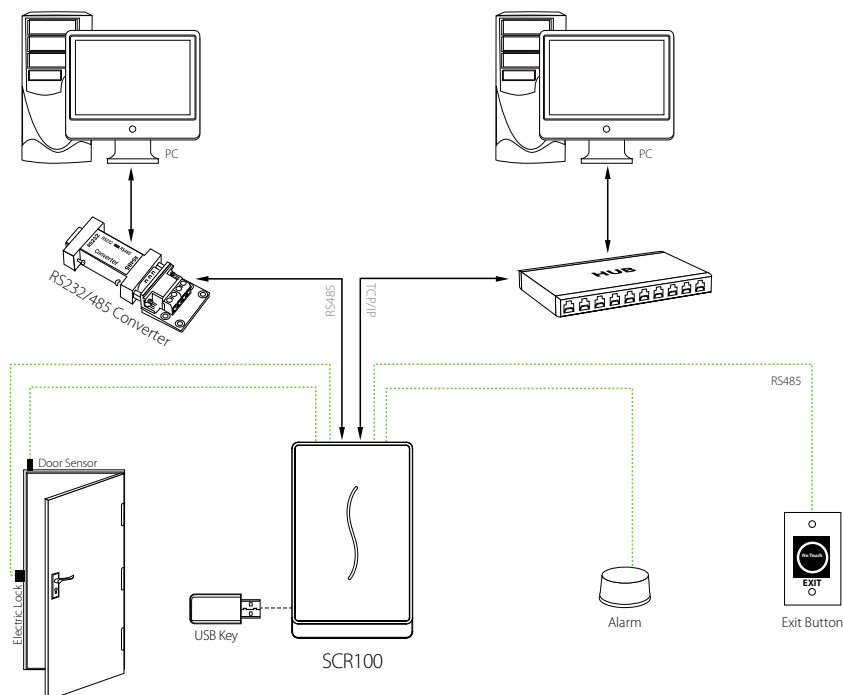



Catalogue number: 195102



## STANDALONE OR NETWORK ACCESS CONTROL AND TIME ATTENDANCE TERMINAL, EL-TFS70

EL-TFS70 is standalone or network biometric access control and time attendance system with high steady and strong access control functions together. With the top algorithm to make sure the identification speed and rates, suits all company and buildings.

### FEATURES

- Touch keyboard
- Multiple identification options: fingerprint, password or card. Identification options can be combined together.
- 500 Dip hidden fingerprint sensor for dry fingerprint and strong sunshine.
- Wiegand in/out to combine with access controller.
- Standard TCP/IP, RS485, USB for communication with computer and server together.
- With software management together for time attendance and access control.
- Excel report for check-in and check-out
- USB to download attendance report
- Lighted keypad for easier operation and using at night.
- Free SDK and free software.
- Two door interlock function: A door open, B door closed.

### TECHNICAL DATA

- Power supply: 12V DC, 1A
- Identification: Fingerprint / Card/ Password
- Identification speed: <1 sec
- Working frequency: 13.56MHz
- Fingerprint capacity: 3000
- Card capacity: 3000
- Display: 2.0 TFT color LCD
- Communication: WAN remote/ RS485 / TCP / IP / USB / WiFi
- Other Functions: Mifare / WiFi
- Time zone and groups: 8 time zones and 8 time groups, 5 combinations
- Wiegand out: Wiegand 26 and 34
- Input: Door sensor, exit button
- Output: Electric lock
- Alarm: Defend, unlock and threaten
- Anti-passback: In and out door
- Size: 190x80x33mm



- Fingerprint capacity: 3000
- Communication: USB, RS485, TCP/IP, (Option WiFi)



### Optical fingerprint recognition

- Backlit fingerprint head
- Finger, PIN, Card

**3 YEARS TOTAL WARRANTY**  
+ 3 standard  
0 extended



Catalogue number:195105



## STANDALONE ACCESS CONTROLLER RFID, HID AND MIFARE EL-SK2X, IP66

EL-SK2X is single door multifunction standalone access controller or a Wiegand output reader. It uses Atmel MCU assuring stable performance.

The operation is very user friendly and low power circuit makes is long service life.

The EL-SK2X supports 600 users (598common + 2panic users), multi access modes in card access, PIN access, Card + PIN access or multi card. Card interface are 125KHz RFID or HID and 13,56MHz Mifare card. It has extra features including block enrollment, Interlock, Wiegand 26-37 bits interface and etc...

### FEATURES

- Waterproof- IP66
- One relay, keyboard controller
- 600 users
- PIN length: 4-6 digits
- Work with multiple card types: 125KHz RFID and HID cards and 13,56MHz Mifare card
- Wiegand 26-37 bits input and output
- Can be used as Wiegand reader with LED and buzzer output
- Card block entrolment
- Three colour LED status display
- Integrated alarm and buzzer output
- Pulse and toggle modes
- Built-in light dependent resistor (LDR) for anti tamper
- Support interlock function for places with requirement of higher security levels
- Low temperature resistance

### TECHNICAL DATA

- Operating voltage: 9-18V DC
- Idle current: <35mA
- Users capacity: 600
- Common user: 598
- Panic user: 2
- Proximity card reader: HID, EM and Mifare
- Radio technology: 125KHz and 13,56MHz
- Read distance: 2-6cm
- Relay: NO, NC, Common
- Adjustable relay output time: 1-99s
- Lock output load: 2A max.
- IP66
- Operating temperature: from -40° to 60°C
- Operating humidity: 0-98% RH
- Body material: ABS
- Dimensions LxWxH (mm): 122x50x210
- Weight: 165g

### Common Power Supply

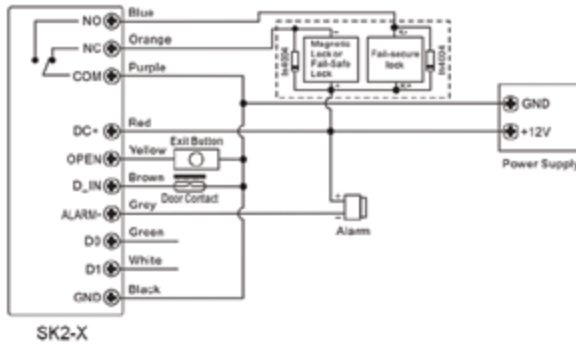

### Access Control Power Supply

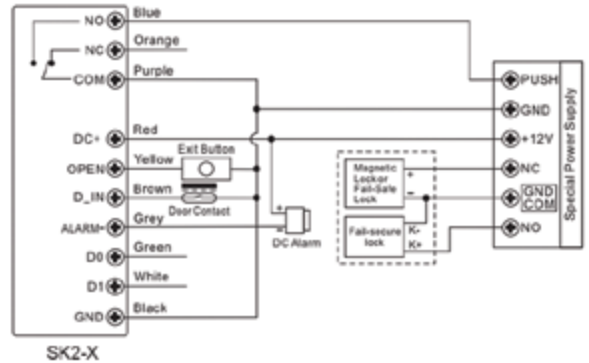

### Work As Wiegand Reader

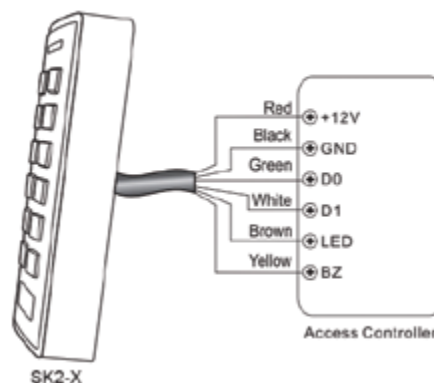

**3 YEARS TOTAL WARRANTY**  
+ 3 standard  
0 extended



Catalogue number:195103



## DYNAMIC FACE RECOGNITION, TIME ATTENDANCE AND ACCESS CONTROL TERMINAL, EL-AI05

The EL-AI05 is a dynamic face access control terminal with time attendance. It uses multi-language software and mobile APP

### FEATURES

- Five people face recognition at same time
- Flexible face recognition distance: 0.5 - 2.5M
- Verification logs transfer to software in real time
- Mask detection and face recognition with wearing mask
- Exporting attendance report from EL-AI05 to PC
- Intelligent cloud platform for mobile APP
- Support RFID
- WDR technology
- HD IPS Touch screen with resolution 1280x720

### TECHNICAL DATA

- Input voltage: 12V DC
- CPU: 1.2G Dual core ARM Cortex-A7
- NPU: 600G (0.6T)
- RAM: 256M DDR3L
- ROM: 4G EMMC
- Camera: 2MP Infrared HD wide range dynamic
- Display: 5 inch HD IPS touch screen. Resolution 1280x720
- Communication port: TCP/IP, USB-Type A(Support U disk), Wifi
- OS: Linux
- Verify method: Face recognition, ID Card, Password or combination
- Face, Card and password capacity: 5000
- Face recognition speed: <0.2s
- Face recognition distance: 0.5-2.5 meters (adjustable)
- Face recognition peoples capacity: 5 at same time
- Face recognition: Live- reject photo and video
- Wiegand: WG 26/34 output
- Support exit button and door bell
- Working temperature: 0-45°C
- Dimension: 155x133x25.5mm

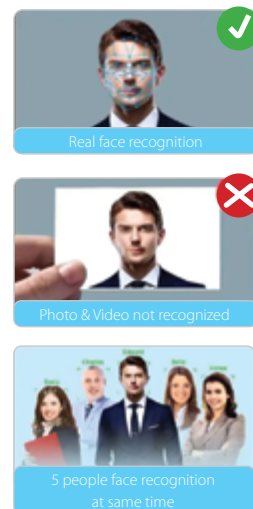

**3 YEARS TOTAL WARRANTY**  
+ 3 standard  
0 extended



Catalogue number: 195095

### RFID MINI WIEGAND CARD READER 125KHZ, EL-PCD97

Wiegand refers to the technology used in card readers and sensors. This system is a wired communication interface that operates between a reader and a controller.

#### TECHNICAL DATA

- Type: Mini Wiegand card reader
- Model: EL-PCD97
- Working frequency: 125KHz
- Card type: EM (RFID)
- Card reading distance: 5-10cm
- Working voltage: 5-16V DC
- Static current: ≤80mA
- Output Format: 26bit/34bit Wiegand
- Communication Distance: 100M
- Working temperature: from -20°C to 65°C
- Humidity: 90% RH (non-condensing)
- Material: ABS
- Dimensions (LxWxH): 80x43x14mm



IP68

Catalogue number: 195096

### RFID MINI WIEGAND CARD READER 125KHZ, EL-M005

EL-M005 is IP68 metal case RFID Wiegand card reader for entry solutions. This system is a wired communication interface that operates between a reader and a controller.

#### FEATURES

- Metal shell, anti-vandal
- Very low power consumption, standby current less than 30mA
- WG 26 output
- Fast Search speed: time between reading card and opening the door is less than 0.1s

#### TECHNICAL DATA

- Type: Waterproof metal case mini Wiegand card reader
- Model: EL-M005
- Working frequency: 125KHz
- Card type: EM (RFID)
- Card reading distance: 2-5cm
- Working voltage: 12V DC
- Static current: ≤35mA
- Wiegand interface: 26bit/34bit
- Working temperature: from -40°C to 60°C
- Humidity: 90% RH (non-condensing)
- IP code: IP68
- Material: Metal
- Dimensions (LxHxD): 48x95x19mm

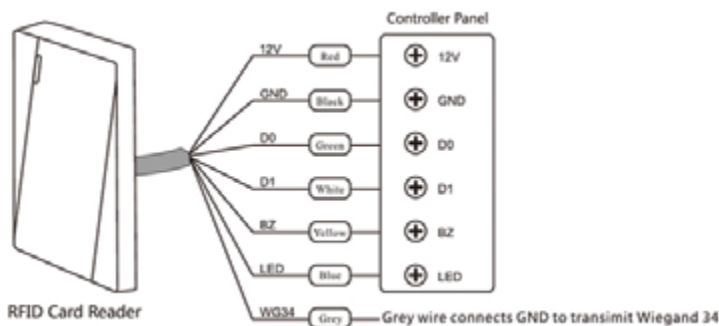

**3 YEARS TOTAL WARRANTY**  
+ 3 standard  
0 extended





### WIEGANG RFID, HID AND MIFARE READER EL-S1RX, IP66

EL-S1RX reader is with advanced 125KHz and 13,56MHz radio technology. It is an ideal choice for high- security applications. It is attractively designed with thin profile and modern appearance.

#### FEATURES

- Waterproof- IP66
- Work with multiple card types: 125KHz RFID and HID cards and 13,56MHz Mifare card
- Low temperature resistance

#### TECHNICAL DATA

- Operating voltage: 9-24V DC
- Idle current: <35mA
- Frequency: 125KHz and 13,56MHz
- Read distance: 2-7cm
- Output format: Wiegang 26
- IP66
- Operating temperature: from -40° to 60°C
- Operating humidity: 0-95% RH
- Body material: ABS
- Colour: Black
- Dimensions LxWxH (mm): 20x48x103
- Weight: 100g

Catalogue number:195104

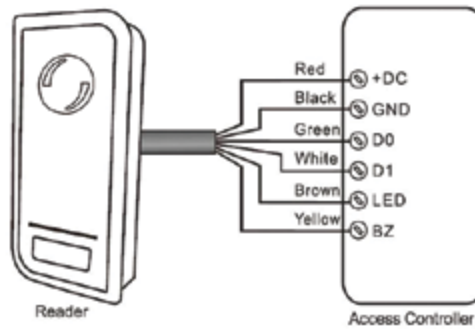

### ZINC ALLOY EXIT BUTTON FOR SURFACE MOUNTING, EL-EB53A

Robust exit button with LED back light in metal design, intended for connection to access systems.

#### TECHNICAL DATA

- Type: Metal EXIT button for access control, surface mounting
- Model: EL-EB53A
- Input voltage: 12-24V DC
- Nominal current: 0.33A/ 12V DC
- Output current: 5A
- Output Contact: NO/COM
- Mechanical Life: 500000
- Material: Zinc alloy
- Dimensions (LxHxD): 53x53x25mm

Catalogue number: 195099



**3 YEARS TOTAL WARRANTY**  
+ 3 standard  
0 extended



Catalogue number: 196000

### MOVING HAND EXIT SENSOR FOR SURFACE MOUNTING, EL-T6C

Moving hand sensor EXIT devices with double LED indication, intended for connection to access systems.

#### TECHNICAL DATA

- Type: No touch device with moving sensor for access control for surface mounting
- Model: EL-T6C
- Input voltage: 12-24V DC
- Output Contact: NO/NC/COM
- LED Indication: Blue (standby) and green (active)
- Time delay: 0-30s adjustable
- Mechanical Life: 500000
- Working temperature: from -20°C to 55°C
- Humidity: 95% RH (non-condensing)
- Material: PC case+ABS face plate
- Dimensions (LxHxD): 55x86x14mm

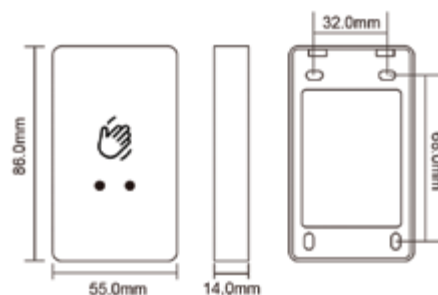
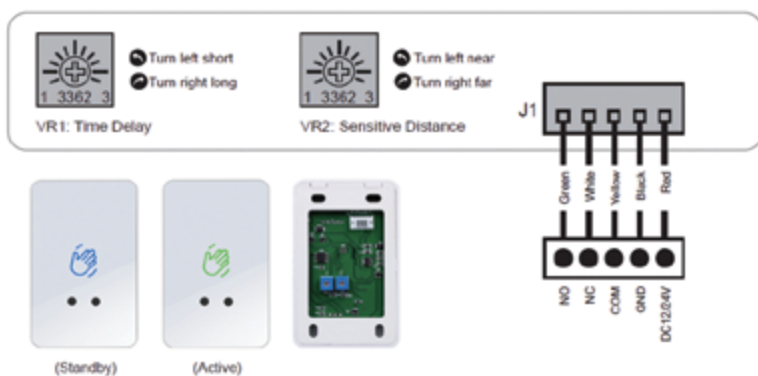

**3 YEARS TOTAL WARRANTY**  
+ 3 standard  
0 extended

### IP68 ZINC ALLOY MOVING HAND INFRARED EXIT SENSOR FOR SURFACE MOUNTING, EL-EB1406

Waterproof zinc alloy moving hand sensor EXIT devices with double LED indication, intended for connection to access systems.

#### TECHNICAL DATA

- Type: No touch waterproof device with moving sensor for access control for surface mounting, IP68.
- Model: EL-EB1406
- Input voltage: 12V DC
- Nominal current: 0.33A/ 12V DC
- Output Contact: NO/NC/COM
- Detection distance: 3-15cm adjustable
- LED Indication: Blue (standby) and green (active)
- Mechanical Life: 100000
- Working temperature: from -20°C to 55°C
- Humidity: 95% RH (non-condensing)
- Material: Zinc alloy
- Dimensions (LxHxD): 80x32x23mm



IP68

Catalogue number: 196001



### RFID ACCESS CONTROL CARD 125 KHZ, EL-EM22



#### TECHNICAL DATA

- Type: Access control entry RFID card 125kHz
- Model: EL-EM22
- Material: PVC
- Colour: White
- Frequency: 125kHz, ID
- Working temperature: from -100°C to 500°C
- Dimensions (LxH): 85.5x54mm



Catalogue number:196002

### RFID ACCESS CONTROL KEY FOB 125 KHZ, EL-TAG2



#### TECHNICAL DATA

- Type: Access control entry RFID key fob 125kHz
- Model: EL-TAG2
- Material: ABS
- Colour: Blue
- Frequency: 125kHz
- Working temperature: from -10°C to 50°C
- Dimensions (LxH): 36x29mm



Catalogue number:196003

### MIFARE ACCESS CONTROL CARD 13.56MHZ, EL-MF26

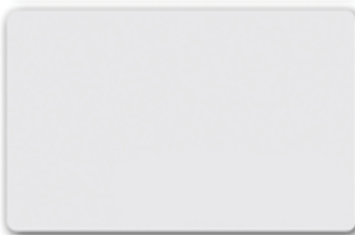

#### TECHNICAL DATA

- Type: Access control entry MIFARE card 13.56MHz
- Model: EL-MF26
- Material: PVC
- Colour: White
- Frequency: 13.56MHz, MIFARE
- Working temperature: from -100°C to 500°C
- Dimensions (LxH): 85.5x54mm



Catalogue number: 196007

### MIFARE ACCESS CONTROL KEY FOB 13.56MHZ, EL-TAG3



#### TECHNICAL DATA

- Type: Access control entry MIFARE key fob 13.56MHz
- Model: EL-TAG3
- Material: ABS
- Colour: Blue
- Frequency: 13.56MHz, MIFARE
- Working temperature: from -10°C to 50°C
- Dimensions (LxH): 33x41mm



Catalogue number: 196009

### HID ACCESS CONTROL THICK CARD 125KHZ, EL-HID01

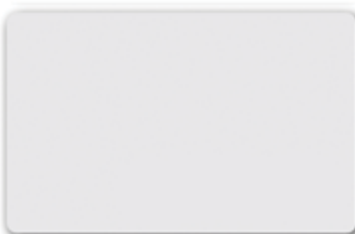

#### TECHNICAL DATA

- Type: Access control entry HID thick card 125KHz
- Model: EL-HID01
- Material: PVC
- Colour: White
- Frequency: 13.56MHz, MIFARE
- Working temperature: from -100°C to 500°C
- Dimensions (LxH): 85.5x54mm



Catalogue number: 196008



Catalogue number:195098

### SWITCH POWER SUPPLY CONTROLLER, EL-K80C

EL-K80C power supply controller is a transformer which provides stable output voltage for access controller, lock, and exit button. NC / NO outputs, can control various types of electric locks, Based delay control circuit. The scope of application applied to a variety of building intercom, villa doorbell, apartment door phone, home video door phone controller, access a variety of import and export controls.

#### TECHNICAL DATA

- Type: Switch power supply controller for access control
- Model: EL-K80C
- Input voltage: 90-260V AC
- Output voltage: 12V DC
- Output current: 5A
- Time delay: 0-15sec (Adjustable)
- Contact: Access control, electric lock, release button contacts
- Security: Protection automatically when the voltage is high
- LED indication: Working status, NO contact status, NC contact status
- Suitable For: Access control, electric lock
- Dimensions (LxH): 130x92mm



Catalogue number:196006

### SWITCH POWER SUPPLY CONTROLLER, EL-K80

EL-K80 power supply controller is a transformer which provides stable output voltage for access controller, lock, and exit button. NC / NO / COM outputs, can control various types of electric locks, Based delay control circuit. The scope of application applied to a variety of building intercom, villa doorbell, apartment door phone, home video door phone controller, access a variety of import and export controls.

#### TECHNICAL DATA

- Type: Switch power supply controller for access control
- Model: EL-K80
- Input voltage: 110-240V AC
- Output voltage: 12V DC
- Output current: 3A
- Time delay: 0-15sec (Adjustable)
- Contact: Access control, electric lock, release button contacts
- Security: Protection automatically when the voltage is high
- LED indication: Working status, NO contact status, NC contact status
- Suitable For: Access control, electric lock
- Dimensions (LxH): 115x90mm



**3 YEARS TOTAL WARRANTY**  
+ 3 standard  
0 extended



Catalogue number: 195110

## MANUAL PARKING LOCK, EL-PL06

EL-PL06 is spray painted manual parking lock made from cold rolled steel plate.

### TECHNICAL DATA

- Locking height: 35cm
- Dimension: 55x44x35cm
- Colour: Orange
- Weight: 6kg
- Material: cold rolled steel
- Material thickness: 2mm



Catalogue number: 195111

## REMOTE CONTROL PARKING LOCK EL-PL02, IP67

EL-PL06 is featured by nice appearance, easy control, strong construction and high security and reliability etc. The parking lock can effectively avoid the misusing or occupation of the parking lot and is a good assistant for parking lot managements of top-grade residential areas, shopping centers, hotels, offices and airports etc.

**CONTROL:** Local via remote control

### TECHNICAL DATA

- Rated voltage: 6V DC
- Battery: 7.4V 3000mA Li-ion
- Charging time: 4h
- Working time: 6-8 months
- Material: Thickened high-temperature alloy steel plate (one-time stamping forming)
- Base thickness: 2.5mm
- Shell thickness: 2.0mm
- Product weight: 8 kg
- Working time: 6-8 months

- Colour: Orange
- Weight: 8kg
- IP67
- Output speed: 7rpm
- Output torque: 50kgN/cm
- Raising or lowering running time: ≤5s
- Control distance: ≤50m
- Working temperature: from -25°C to 55°C
- Lifting height: 400mm
- Drop height: 80mm
- Dimension: 400x450mm



Catalogue number: 195114

## SMART SOLAR PARKING LOCK EL-PB903, IP67

Smart solar parking lock is made of carbon steel. It is controlled by remote controllers and "KAVASS" APP. And It is designed for parking spaces protection with well-marked shap.

**CONTROL:** Local via remote control, Bluetooth or APP

### FEATURES

- Burglar-proof
- Waterproof
- Strong stability
- Powered with solar energy
- Multiple open/close types

### SET INCLUDED

- Automatic parking lock: 1pc
- Battery: 1pc
- Mechanical key: 2pcs
- Remote control: 2pcs
- Anchors: 3pcs

### TECHNICAL DATA

- Rated voltage: 6V DC
- Battery: Lead acid battery
- Standby Voltage: 6.80-6.90V
- Cycle Voltage: 7.05-7.20V
- Material: Carbon steel
- Product weight: 8 kg
- Colour: Yellow and black
- Weight: 8kg
- Operation angle: 180°
- Load bearing: 2 tons
- Remote control working distance: 50m
- IP67
- Working temperature: from -18°C to 50°C
- Rising height: 550mm
- Dimension: 450x610x70mm





Catalogue number:195112



## AUTOMATIC BARRIER GATE WITH STRAIGHT ADJUSTABLE ARM FROM 3.2 TO 6 METERS, EL-BG007

EL-BG007 is fully automatic vehicle parking barrier gate with straight octagonal arm for parking and road.

### FEATURES

- Safety: 24V power supply to protect personal safety
- Energy saving: Static power is less than 2W
- Speed adjustable
- Smooth working: Multi-stage speed design
- Multi-protection: motor over current, overload, short circuit, motor failure, power reverse connection protection
- Anti-smashing technology
- "Specially designed integrated motor with reduces body vibration to greatly improves the operating accuracy of the barrier gate barrier gate"
- Possibility for change the direction of the gate opening: to the left or right
- Boom (arm) length adjustment: from 3.2 to 6m
- LED light indication
- Suitable with EL-R02

### TECHNICAL DATA

- Boom (arm) length adjustment: from 3.2 to 6m. Choice length possibility- 3.2m; 3.3m; 3.4m; 5m and 6m
- Material: 304 Stainless steel
- Body color: Black
- Power Supply: 24V AC/50Hz
- Power consumption: 100W
- Open/close speed: 1-6s adjustable
- Working temperature: from -30°C to 60°C
- Gate dimension: 350x300x975mm



Catalogue number:195113



## ANTI-SMASHING RADAR EL-R02 FOR AUTOMATIC BARRIER GATE EL-BG007

EL-R02 is anti-collision radar, suitable only for straight (boom) arm barrier gate.

The anti-smashing radar is installed on the barrier gate box perpendicular to the direction of the lane (or installed on the column next to the box). The installation height is recommended to be 0.6M from the bottom edge of the radar to the ground, and 15-25CM from the gate lever on the left and right.

### TECHNICAL DATA

- Input voltage: 12V DC; 150mA
- Scope of application: Straight bar gate
- Working frequency: 24 - 24.5GHz
- Horizontal beam: < 30°
- Vertical beam: < 17°
- Working temperature: from -30°C to 60°C
- Detection distance: 1-6 meters (+0.1 meters)
- Working temperature: from -40°C to 85°C
- IP67
- Dimension: 105x118x21mm

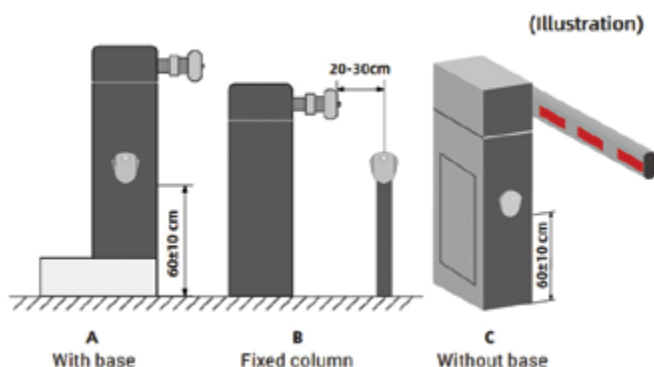

**3 YEARS TOTAL WARRANTY**  
 + 3 standard  
 0 extended

# SMART HOME CATEGORY

Select a language and scan the code with any code scanner to read the catalog in:

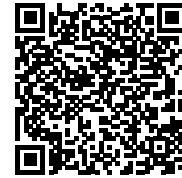

# DOORBELLS





WIRELESS DOORBELLS WITH LED FLASH LIGHT



Catalogue number	QTY Transmitter/ Receiver	Voltage (V)	Sound level db(A)	Volume levels	Music	Distance (m)	Packing/ Box (pcs)
5020	One/One	220	65-85	Low/ Middle/ High	36 melodies	80	1/60

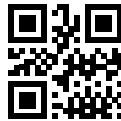

Transmitter battery: 12V A23  
The item is without a coded frequency! Within a montage at a distance less than 80 meters and of two or more analogue doorbells, their work can be influenced by or disturbances to happen.



Catalogue number	QTY Transmitter/ Receiver	Voltage (V)	Sound level db(A)	Volume levels	Music	Distance (m)	Packing/ Box (pcs)
5016	One/One	220	65-85	Low/ Middle/ High	36 melodies	80	1/60



Transmitter battery: 12V A23  
The item is without a coded frequency! Within a montage at a distance less than 80 meters and of two or more analogue doorbells, their work can be influenced by or disturbances to happen.



Catalogue number	QTY Transmitter/ Receiver	Voltage (V)	Sound level db(A)	Volume levels	Music	Distance (m)	Packing/ Box (pcs)
5019	One/One	220	65-85	Low/ Middle/ High	36 melodies	80	1/60



Transmitter battery: 12V A23  
The item is without a coded frequency! Within a montage at a distance less than 80 meters and of two or more analogue doorbells, their work can be influenced by or disturbances to happen.



Catalogue number	QTY Transmitter/ Receiver	Voltage (V)	Sound level db(A)	Volume levels	Music	Distance (m)	Packing/ Box (pcs)
5015	One/Two	220	65-85	Low/ Middle/ High	36 melodies	80	1/60



Transmitter battery: 12V A23  
The item is without a coded frequency! Within a montage at a distance less than 80 meters and of two or more analogue doorbells, their work can be influenced by or disturbances to happen.

**2 YEARS TOTAL WARRANTY**  
+ 2 standard 0 extended



Catalogue number	QTY Transmitter/ Receiver	Voltage (V)	Sound level db(A)	Volume levels	Music	Distance (m)	Packing/ Box (pcs)
5018	One/Two	220	65-85	Low/ Middle/ High	36 melodies	80	1/60



Transmitter battery: 12V A23

The item is without a coded frequency! Within a montage at a distance less than 80 meters and of two or more analogue doorbells, their work can be influenced by or disturbances to happen.



Catalogue number	QTY Transmitter/ Receiver	Transmitter Voltage (V)	Receiver Voltage (V)	Sound level db(A)	Volume levels	Music	Distance (m)	Packing/ Box (pcs)
5023/1	One/One	12V 23A Battery	DC 3x1.5V AAA Battery	70-85	Low/ Middle/ High	36 melodies	80	1/60
5024	One/One	12V 23A Battery	220V AC	70-85	Low/ Middle/ High	36 melodies	80	1/60

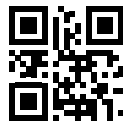

The item is without a coded frequency! Within a montage at a distance less than 80 meters and of two or more analogue doorbells, their work can be influenced by or disturbances to happen.



Catalogue number	QTY Transmitter/ Receiver	Transmitter Voltage (V)	Receiver Voltage (V)	Sound level db(A)	Volume levels	Music	Distance (m)	Packing/ Box (pcs)
5023/2	One/Two	12V 23A Battery	DC 3x1.5V AAA Battery	70-85	Low/ Middle/ High	36 melodies	80	1/60



The item is without a coded frequency! Within a montage at a distance less than 80 meters and of two or more analogue doorbells, their work can be influenced by or disturbances to happen.

**2 YEARS TOTAL WARRANTY**  
+ 2 standard  
0 extended

## SELF-POWERED DIGITAL WIRELESS DOORBELLS WITH LED FLASH LIGHT



Catalogue number	QTY Transmitter/ Receiver	Transmitter Voltage (V)	Receiver Voltage (V)	Sound level db(A)	Volume levels	Music	Distance (m)	Packing/ Box (pcs)
5027WH	One/Two	Self-powered	220V AC	70-85	Low/ Middle/ High	4 chord/ 36 melodies	100-120	1/60



Catalogue number	QTY Transmitter/ Receiver	Transmitter Voltage (V)	Receiver Voltage (V)	Sound level db(A)	Volume levels	Music	Distance (m)	Packing/ Box (pcs)
5027BL	One/Two	Self-powered	220V AC	70-85	Low/ Middle/ High	4 chord/ 36 melodies	100-120	1/60



**2 YEARS TOTAL WARRANTY**  
+ 2 standard  
0 extended

DIGITAL WIRELESS DOORBELLS WITH LED FLASH LIGHT



Catalogue number	QTY Transmitter/ Receiver	Transmitter Voltage (V)	Receiver Voltage (V)	Sound level db(A)	Volume levels	Music	Distance (m)	Packing/ Box (pcs)
5025WH	One/One	12V 23A Battery	DC 2x1.5V AA Battery	70-85	Low/ Middle/ High	32 melodies	120	1/60



Catalogue number	QTY Transmitter/ Receiver	Transmitter Voltage (V)	Receiver Voltage (V)	Sound level db(A)	Volume levels	Music	Distance (m)	Packing/ Box (pcs)
5025BL	One/One	12V 23A Battery	DC 2x1.5V AA Battery	70-85	Low/ Middle/ High	32 melodies	120	1/60



Catalogue number	QTY Transmitter/ Receiver	Transmitter Voltage (V)	Receiver Voltage (V)	Sound level db(A)	Volume levels	Music	Distance (m)	Packing/ Box (pcs)
5026	One/One	12V 23A Battery	220V AC	70-85	Low/ Middle/ High	36 melodies	100	1/60



**2 YEARS TOTAL WARRANTY**  
+ 2 standard  
0 extended

## INFRARED INDUCTION DOORBELLS



An electric appliance with inserted motion sensor. It is used for advisement for guests,visitors or customers. When there is a motion ,it starts / there is a sound which advises that there is a visitor/ customer/ in the premises. Working area - up to 7 meters

Catalogue number	Description	Voltage (V)	Sound level db(A)	Detection angle	Sensor detection distance (m)	Music	Packing/ Box (pcs)
5021	Doorbell with sensor	4.5V DC	85	100°	up to 7	36 melodies	1/60



A complex product that combines two appliances. It is used for advisor for guests,visitors or customers. The sensor is installed to the place that you would like to know there is a motion/ visitor,this usually is the shop entrance,offices,warehouses and etc. The bell can be installed at a distance up to 130 m from the sensor which we will receive the signal for motion /visitor. Working frequency: 315MHz/433.92 MHz

Catalogue number	Description	Voltage (V)	Sound level db(A)	Detection angle	Sensor detection distance (m)	Music	Packing/ Box (pcs)
5022	Doorbell & sensor	4,5V DC	85	100°	up to 7	36 melodies	1/60



**2 YEARS TOTAL WARRANTY**  
+ 2 standard  
0 extended

BELL / BELL TRANSFORMER



Mounting: on DIN-rail

Catalogue number	Type	In (V)	Un (V)	Consumption (VA)	Sound level db(A)	Packing/Box (pcs)
5012	Bell	230	8-12	3.6	70	1/12/240
5220	Bell	230	230	5	70	1/12/240



Mounting: on DIN-rail

Catalogue number	Type	In (V)	Un (V)	Consumption (VA)	Packing/Box (pcs)
5001	Bell transformer	230	8/12/24	8	1/80



**5 YEARS TOTAL WARRANTY**  
+ 5 standard  
0 extended